



Operator Manual

For printer models:

S8408 / S8412 / S8424



PN: 9001160 (D)

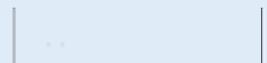

Copyrights

The contents of this document are proprietary information of SATO Corporation and/or its subsidiaries in Japan, the U.S and other countries. No part of this document may be reproduced, copied, translated or incorporated in any other material in any form or by any means, whether manual, graphic, electronic, mechanical or otherwise, without the prior written consent of SATO Corporation.

FCC Statement

The printer complies with the requirements in Part 15 of FCC Rules for a Class B Computing Device. Operating the printer in a residential area may cause unacceptable interference to radio and TV reception. If the interference is unacceptable, you can reposition the equipment, which may improve reception.

Limitation of Liability

SATO Corporation and/or its subsidiaries in Japan, the U.S. and other countries, make no representations or warranties of any kind regarding this material, including, but not limited to, implied warranties of merchantability and fitness for a particular purpose. SATO Corporation shall not be held responsible for errors contained herein or any omissions from the materials or for any damages, whether direct, indirect, incidental or consequential, in connection with the furnishing, distribution, performance, or use of this material.

SATO Corporation reserves the right to change or improve this product and document without notice.

Trademarks

SATO is a registered trademark of SATO Corporation and/or its subsidiaries in Japan, the United States, and other countries.

SATO America, Inc.
10350 Nations Ford Road
Charlotte, NC 28273
Main Phone: (704) 644.1650
Technical Support: (704) 644.1660
Technical Support Fax: (704) 644.1661
E-Mail: satosales@satoamerica.com
www.satoamerica.com
© Copyright 2006-2012 SATO America, Inc.
All rights reserved.

Table of Contents

INTRODUCTION	1-1
About this Manual	1-1
General Description.....	1-2
Control Features.....	1-3
TECHNICAL DATA	2-2
Physical Characteristics.....	2-2
Power.....	2-2
Environmental	2-2

Table of Contents

Processing 2-2
Command..... 2-2
Interface Modules..... 2-3
Regulatory Approvals..... 2-3
Print..... 2-3
Media 2-3
Ribbon..... 2-4
Sensing 2-4
Character Font Capabilities..... 2-4
Bar Code Capabilities..... 2-5

INSTALLATION..... 3-2

Unpacking 3-2
Printer Installation..... 3-3
Site Location 3-3
Installation Requirements..... 3-4
Printer Loading..... 3-6
Media Selection..... 3-6
Media Loading..... 3-6
Ribbon Loading..... 3-7
Operational Mode Selection..... 3-8
Dispense Mode 3-8
Continuous Mode..... 3-8
Interface Selection 3-9
RS232C High-Speed Serial Interface..... 3-10
IEEE1284 Parallel Interface..... 3-12
Universal Serial Bus (USB)..... 3-13
Local Area Network (LAN) Ethernet..... 3-14
802.11G Wireless..... 3-15
All Interfaces 3-17
Receive Buffer..... 3-17
ACK/NAK Protocol 3-17
Status5 Return 3-17
External Signal..... 3-21
Accessories Installation..... 3-27
Interface Installation..... 3-27
Remote Operator Interface Kit 3-28

PRINTER CONFIGURATION..... 4-2

Configuration Modes..... 4-3
User Mode..... 4-3
Advanced Mode 4-4

Table of Contents

Parallel Interface Mode 4-5
Serial Interface Mode..... 4-6
Local Area Network (LAN) Interface Mode..... 4-7
Universal Serial Bus (USB) Mode..... 4-8
Centronics Interface Mode..... 4-9
Wireless LAN (Local Area Network) Interface Mode..... 4-10
Service Mode 4-11
Factory Mode 4-12
Factory Mode With RFID Installed 4-13
RFID User Mode 4-14
Work Shift Mode..... 4-15
Hidden Mode..... 4-16
Download Mode 4-17
Boot Download Mode..... 4-18
Print Cancel Mode..... 4-19
Default Settings Mode..... 4-20
Test Print Mode..... 4-21
Hex Dump Mode 4-22
CF (Compact Flash) Card Mode..... 4-23
Stand Alone Mode..... 4-24
SATO + SZPL Emulation Mode 4-25
Menu Definition Tables..... 4-26

TROUBLESHOOTING 5-2

Error Signal Troubleshooting..... 5-2
Warning Signal Troubleshooting..... 5-6
Troubleshooting Table..... 5-7
Interface Troubleshooting..... 5-9
Parallel Interface 5-9
RS232 Serial Interface..... 5-9
Universal Serial Bus (USB) Interface..... 5-9
LAN Ethernet Interface..... 5-10
Wireless LAN Interface..... 5-10
Centronics Interface..... 5-10
Test Print Troubleshooting..... 5-11
Hex Dump Mode 5-11
Test Label Printing 5-12
Sample Test Label 5-13

MAINTENANCE 6-2

Cleaning Procedures..... 6-2
Replacement Procedures..... 6-3
Print Head Replacement..... 6-3
Platen Roller Replacement..... 6-4
Interface Board Replacement..... 6-5
Fan Filter Replacement..... 6-6
Adjustment Procedures..... 6-7
Label Sensor Positioning..... 6-7
Adjustment of Head Position..... 6-8
Setting Head Pressure and Balance..... 6-10
Ribbon Guide Alignment 6-12
Media Pressure Roller Balance..... 6-13
I-Mark/Paper-End Sensor Sensitivity 6-14
Gap Sensor Sensitivity..... 6-15

Operational Adjustments..... 6-16

APPENDIX..... 7-2

Ready/Busy Timing Charts..... 7-2
X-On/X-Off Timing Charts..... 7-3
Session Connect/Disconnect Diagram..... 7-4
Printer Dimensions (Standard Direct Load)..... 7-5
Printer Dimensions (Opposite Direct Load)..... 7-8

Table of Contents

S8400 Series Operator Manual Page 3 Page 4 *S8400 Series Operator Manual*

1

INTRODUCTION

- About This Manual
- General Description
- Control Features

INTRODUCTION

ABOUT THIS MANUAL

This manual is laid out consistent with the product discussed and provides all of the information required for general printer configuration, operation, troubleshooting, and maintenance. For specialized programming, refer to the Programming Reference document.

Step-by step maintenance instructions are provided with typical problems and solutions. Become familiar with each unit and section before installing and maintaining the printer.

This manual also incorporates the use of special information boxes. Examples of these boxes and the type of information provided in each, are below.

WARNING: PROVIDES INFORMATION THAT, IF UNHEEDED, MAY RESULT IN PERSONAL INJURY.

CAUTION: PROVIDES INFORMATION THAT, IF UNHEEDED, MAY RESULT IN EQUIPMENT DAMAGE.

Unit 1: Introduction

ATTENTION: Provides information that is deemed of special importance but will not result in personal injury or product damage if unheeded.

NOTE: Provides helpful hints to assist in performing the tasks at hand.

LCD DISPLAY: Provides the specific display that should be visible on the LCD at that point.

A comprehensive Table Of Contents provided at the front of this manual facilitates rapid movement within. The contents identify the different Units, Chapters, and some Sections. Each references the page number of their commencement.

The pages of this manual have embedded headers and footers to assist the user in identifying his or her exact position within the manual. The header provides the unit number followed by its name. The footer identifies the product on the left, the page number in the center, and the manual's part number to the right side of the page.

Page enumeration is two-part with each separated by a hyphen. The first character set references the Unit and the second identifies the page number within that unit. Page numbers begin with the numeral one (1) at the beginning of a new unit and ascend sequentially.

ATTENTION: The illustrations and graphics provided in this manual may display components, assemblies, and purchase options that may not be present on individual printers. However, where those instances arise, they are not relevant to the topic discussed.

GENERAL DESCRIPTION

The S8400 series print engines are specifically designed for use in high-volume, automated print/apply labeling applications demanding unparalleled reliability and around the clock operation. These print engines offer four-inch wide printing ability and are available in 203, 305, and 609 dpi print resolution. However, more compelling is their user-friendly design and application flexibility.

These OEM print engines follow the design concepts and principles of SATO's previous, market leading, industrial print engines. The S8400 series can physically and electronically replace any of SATO's previous S-type OEM print engines. Additionally, this printer utilizes the same SATO Barcode Printing Language (SBPL) as drives all current SATO OEM print engines.

The S8400 series print engine is available with options, including ribbon saver and RFID capability.

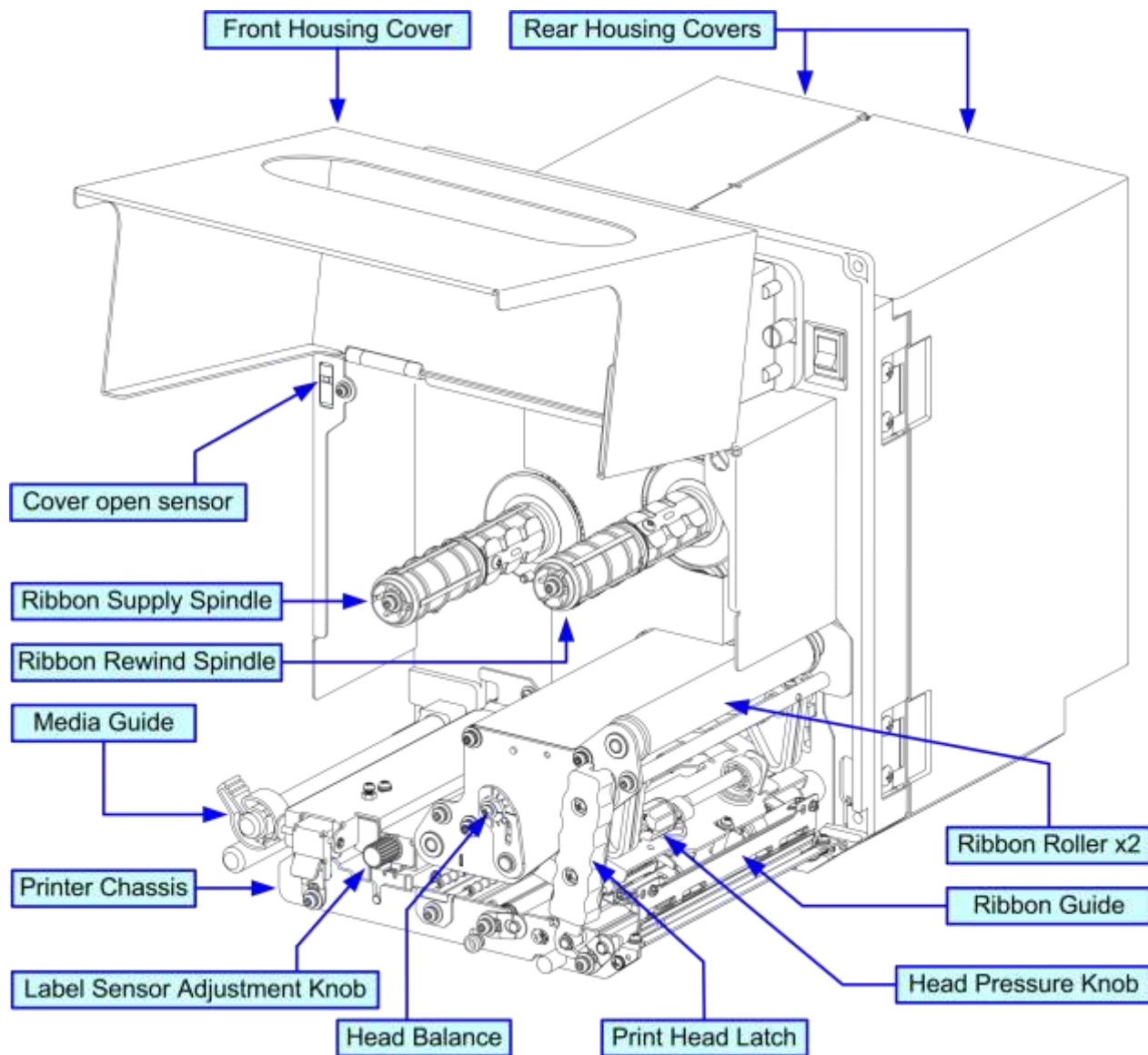

Figure 1-1, Primary Components

CONTROL FEATURES

This chapter identifies the interactive control features of the printer. These functions are defined generally here. More specific explanations will be found throughout this manual on how to use them.

OPERATOR PANEL FEATURES	
LED	DEFINITION
POWER	Illuminates green when the printer is powered on. Terminates when powered off.
ONLINE	Illuminates green when the printer is in an online state. Terminates when the printer goes offline.
LABEL	Off = Normal state. Red Constant = When a Label Error has occurred.
RIBBON	Off = Normal state. Red Flashing = Ribbon supply is low. Red Constant = When a Ribbon Error has occurred.

Unit 1: Introduction

KEYS	DEFINITION
POWER	Removes power supply at its entry to the printer.
LINE	Moves the printer from an online to offline state and vice-versa. Has other special functions as identified in flow charts throughout this manual as applicable.
FEED	Advances the label media when pressed. Has other special functions as identified in flow charts throughout this manual as applicable.
FUNCTION	Pressing steps the LCD back to a previous menu. Has other special functions as identified in flow charts throughout this manual as applicable.
ENTER	Used to select a menu option and to advance the menu screen accordingly. Has other special functions as identified in flow charts throughout this manual as applicable.
CANCEL	Pressing steps the LCD back to a previous menu. Has other special functions as identified in flow charts throughout this manual as applicable.
ARROWS	Allows the operator to scroll through various menus and menu options. Has other special functions as identified in flow charts throughout this manual as applicable.
POTENTIOMETERS	DEFINITION
VOLUME	Allows volume control of the printer's audible alarm.
PITCH	For adjusting the print position.
OFFSET	Adjusts the peel or dispense stop position.
DARKNESS	Adjusts the print density resulting in a lighter or darker print image.

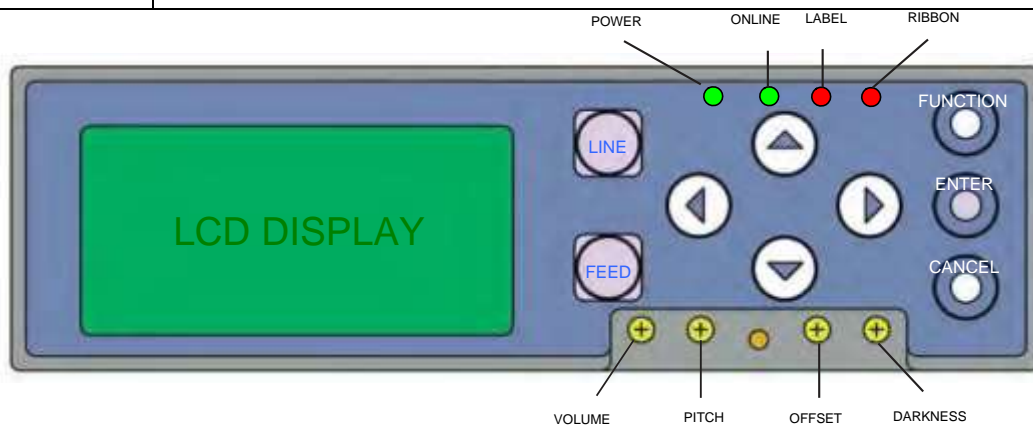

Figure 1-2, Operator Panel

2

TECHNICAL DATA

- **Physical Characteristics**
 - **Power**
 - **Environmental**
 - **Processing**
 - **Command**
- **Interface Modules**
- **Regulatory Approvals**
 - **Print**
 - **Media**
 - **Ribbon**
 - **Sensing**
- **Character Font Capabilities**
 - **Barcode Capabilities**

TECHNICAL DATA

PHYSICAL CHARACTERISTICS

PHYSICAL CHARACTERISTICS	
Typical Width	9.65 Inches (245mm)
Typical Height	11.81 Inches (300mm)
Maximum Depth	18.82 Inches (478mm)
Standard Weight	35.27 Pounds (16.0Kg)

POWER

POWER	
Input Voltage	100-240 Volts AC +/- 10%, 50/60 Hertz +/-5%
Power Consumption	220 Watts, 2.7 to 1.1 Amperes (operating)
Acceleration Performance	1.0G (Frequency: 10Hz, Vibration Time: within 5 minutes)

ENVIRONMENTAL

ENVIRONMENTAL	
Operating Temperature	23 to 104°F (-5° to 40°C)
Storage Temperature	-4 to 140°F (-20° to 60°C)
Storage Humidity	15 to 85% RH Non-Condensing
Operating Humidity	15 to 85% RH Non-Condensing

PROCESSING

PROCESSING	
CPU	32 Bit RISC
Flash ROM	4 Megabytes
SDRAM	16 Megabytes
FRAM	32 Kilobytes
Receive Buffer	Maximum 2.95 Megabytes
SRAM (integrated calendar)	8 Kilobytes

COMMAND**INTERFACE MODULES**

COMMAND	
Standard	SATO Barcode Printer Language (SBPL)
Option	SZPL
INTERFACE MODULES	

Unit 2: Technical Data

Enhanced Parallel Port	IEEE1284 (ECP Compatible)
Serial Port	RS232C (9600 to 57,600 bps) - 25 Pin RS422/485 (9600 to 57600 bps)
Universal Serial Bus (USB)	USB Version 1.1
Local Area Network (LAN)	10BASE-T/100BASE-TX Automatic Switching
Wireless LAN	IEEE802.11b/g Wireless

REGULATORY APPROVALS

REGULATORY	
Safety	MET, NEMKO-GS, C-MET
Radiant Noise	VCCI (Class B), FCC (Class B), EN 55022 (Class B)
Packaging Drop Test	ISTA-2A

PRINT

PRINT	
Method	Direct Thermal / Thermal Transfer
Head Width	4.09 Inches (104mm)
Maximum Speed	S8408: 4 to 16 Inches Per Second (102-406mm/s) S8412: 4 to 14 Inches Per Second (102-356mm/s) S8424: 2 to 6 Inches Per Second (51-152mm/s)
Resolution	S8408: 203 Dots Per Inch (8 dots/mm) S8412: 305 Dots Per Inch (12 dots/mm) S8424: 609 Dots Per Inch (24dots/mm)
Maximum Printable Area	S8408: 4.09 Inches W x 98.4 Inches L (104mm W x 2500mm L). S8412: 4.09 Inches W x 59.0 Inches L (104mm W x 1500mm L) S8424: 4.09 Inches W x 15.7 Inches L (104mm W x 400mm L)

MEDIA

MEDIA			
Width	0.394 to 5.039 Inches (10-128 mm) Media Width with liner: 0.5 to 5.1 Inches (13-131 mm)		
Length (Pitch)	Media Length: 0.6 Inches (15 mm) (to printable area)		
Type	Die-Cut Labels, Waste removed, Roll, 0.125 inch Gap or I-Mark		
Thickness	0.002 to 0.012 Inches (0.05 - 0.31mm)		
MEDIA			
Media Handling	Media Width (mm)	Label Supply Load (grams)	Liner Rewind Load (grams)
	13 to 18	< 250	< 150
	18 to 28	< 400	< 300
	28 to 48	< 900	< 300

Unit 2: Technical Data

	48 to 63	< 1,200	< 400
	63 to 83	< 1,200	< 650
	83 +	< 1,400	< 800

RIBBON

RIBBON			
Width	Minimum: 0.98 Inches (25mm) Maximum: 5.04 Inches (128mm)		
Length	3280 Feet (1000m)		
Ribbon Handling	Ribbon Length (m)	Ribbon Width (mm)	Label Pitch (mm)
	1,000	76	60 +
	600	39.5 to 75	25 +
	450	< 39.5	< 25
Wound	Face In / Face Out		
Roll Diameter	4.252 Inches (108mm)		
Core Diameter	1.01 +/-0.008 Inches (25.6mm +/-0.2mm)		
Color	Black (standard), Other Tints (non-standard)		

SENSING

SENSING	
Gap	Adjustable
Reflective I-Mark	Adjustable
Ribbon Near End	Enable/Disable
Media Out	Adjustable
Cover-Open	Constant
Head-Open	Constant

CHARACTER FONT CAPABILITIES

CHARACTER FONT CAPABILITIES	
MATRIX FONTS	
XU	5 dots W x 9 dots H (Helvetica)
XS	17 dots W x 17 dots H (Univers Condensed Bold)
XM	24 dots W x 24 dots H (Univers Condensed Bold)
OA Font (OCR-A)	203dpi (8dots/mm): 15 dots W x 22 dots H 305dpi (12dots/mm): 22 dots W x 33 dots H 609dpi (24dots/mm): 44 dots W x 66 dots H
CHARACTER FONT CAPABILITIES	

MATRIX FONTS	
OB Font (OCR-B)	203dpi (8dots/mm): 20 dots W x 24 dots H 305dpi (12dots/mm): 30 dots W x 36 dots H 609dpi (24dots/mm): 60 dots W x 72 dots H
AUTO SMOOTHING FONTS	
XB	48 dots W x 48 dots H (Univers Condensed Bold)
XL	48 dots W x 48 dots H (Sans Serif)
VECTOR FONT	
	Proportional or Fixed Spacing Font Size 50 x 50 dots to 999 x 999 dots Helvetica, 10 Font Variations
AGFA RASTER FONTS	
A Font	CG Times, 2 to 99 pt. (4-999 dots)
B Font	CG Triumvirate, 2 to 99 pt. (4-999 dots)
DOWNLOADABLE FONTS	
	Compact Flash Card required
CHARACTER CONTROL	
	Expansion up to 12 x in either the X or Y coordinates. Character Pitch Control Line Space Control Journal Print Facility 0, 90, 180, and 270 Degree Rotation

BAR CODE CAPABILITIES

BAR CODE CAPABILITIES	
Linear Bar Codes	UPC A/E EAN 8/13 Code 39 Code 93 Code 128 Interleaved 2 of 5 Industrial 2 of 5 Matrix 2 of 5 Bookland GS1-DataBar™ MSI POSTNET™ GS1-128 NW-7 (Codabar) Intelligent Mail® Barcode (IMB)

Unit 2: Technical Data

Two Dimensional	QR Code GS1-Data Matrix (ECC200) Maxi Code™ PDF417 (including Micro & Truncated) Composite Symbology
Bar Width Ratio	1:2, 1:3, 2:5, User definable bar widths

BAR CODE CAPABILITIES	
Bar Height	4 to 999 dots, User programmable
Rotation	0, 90, 180, and 270 Degrees
Sequential Numbering	Sequential numbering of both numerics and bar codes
Graphics	Full dot addressable graphics, SATO Hex/Binary, BMP or PCX formats
Form Overlay	Form overlay for high-speed editing of complex formats

3

INSTALLATION

- **Unpacking**
- **Printer Installation**
- **Printer Loading**
- **Operational Mode Selection**
- **Interface Selection**
- **Accessories Installation**

INSTALLATION

UNPACKING

When unpacking the printer, take note of the following:

1. The box should stay right-side up. Lift the printer out of the box carefully.

Unit 3: Installation

2. Remove all of the packaging from the printer.
3. Remove the accessory items from the packaging.
4. Set the printer on a solid, flat surface. Inspect the shipping container and printer for any sign of damage that may have occurred during shipping. Please note that SATO shall hold no liability for any damage of any kind sustained during shipping of the product.
5. Ensure all components are present.
6. Report any damaged property to the shipping carrier.

Notes:

- If the printer has been stored in the cold, allow it to reach room temperature before turning it on.
- Please do not discard the original packaging box and cushioning material after installing the printer. They may be needed in the future, if the printer needs to be shipped for repairs.

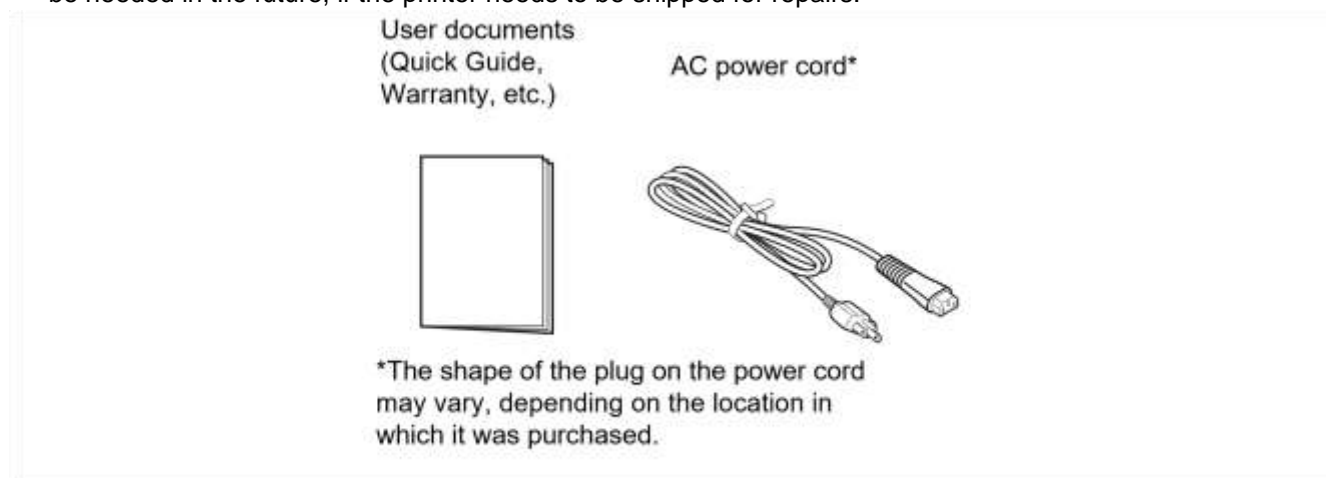

Figure 3-1, Accessories

Included Accessories

After unpacking the printer, verify that you have the materials that are shown in Figure 3-1.

PRINTER INSTALLATION

This chapter provides guidance on how to station, connect, and load the printer once unpacked. Following printer setup, proceed to the next chapter for information on interface selection.

SITE LOCATION

- Stationed away from hazardous materials.
- Stationed within an enclosed structure that conforms to the printer's environmental requirements.
- Stationed within operational distance of the host based on interface specifications.
- Stationed to allow unimpeded access to the printer for operation, loading, and maintenance.

INSTALLATION REQUIREMENTS

The printer has five bores in its center frame for the purpose of mounting to a support structure. Refer to the following list of mounting requirements.

- The support structure must be firmly secured to the floor or production machinery.
- The support structure must be sturdy and stable so as to prevent unnecessary movement or vibration.
- The printer is to be mounted to the support structure using attaching hardware design to accommodate the printer's weight, as well as, the prevailing operational and environmental conditions within the facility.
- A power supply receptacle or junction box is to be properly secured within regulated proximity to the printer.
- The power supply is to be metered conducive to the printer's design requirements.
- The printer must be installed so that its output side is within the designated distance and height relative to the applicator.
- Media supply dispensers must be mounted or placed with operational distance of the printer's input side.

NOTE: Figures 3-2 and 3-3 are to be used as instructional displays only and are not to be literally interpreted as precise examples.



Figure 3-2, Typical Printer/Applicator Process

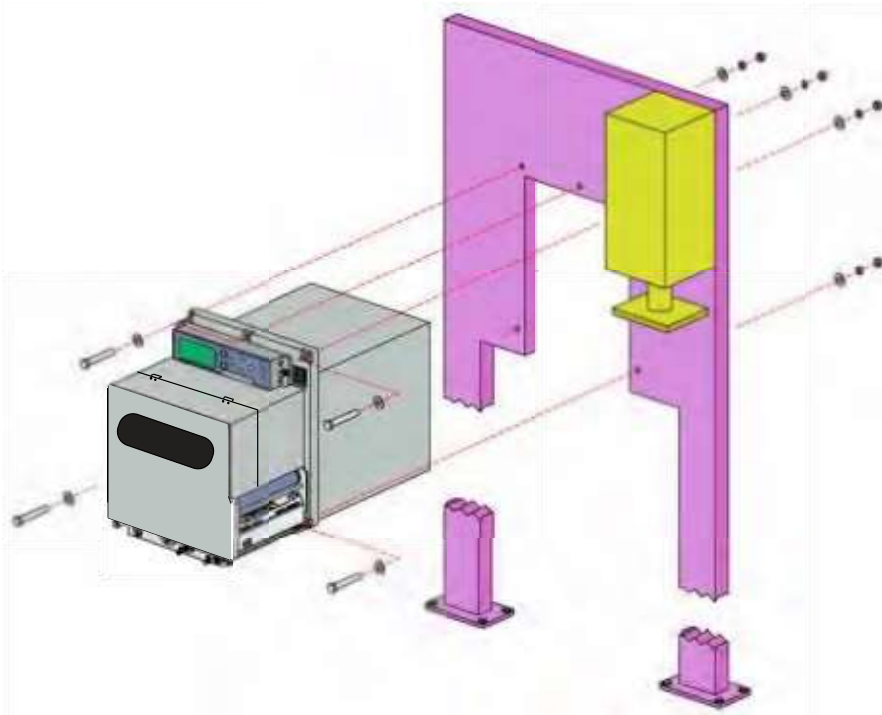

Figure 3-3, Printer Mounting

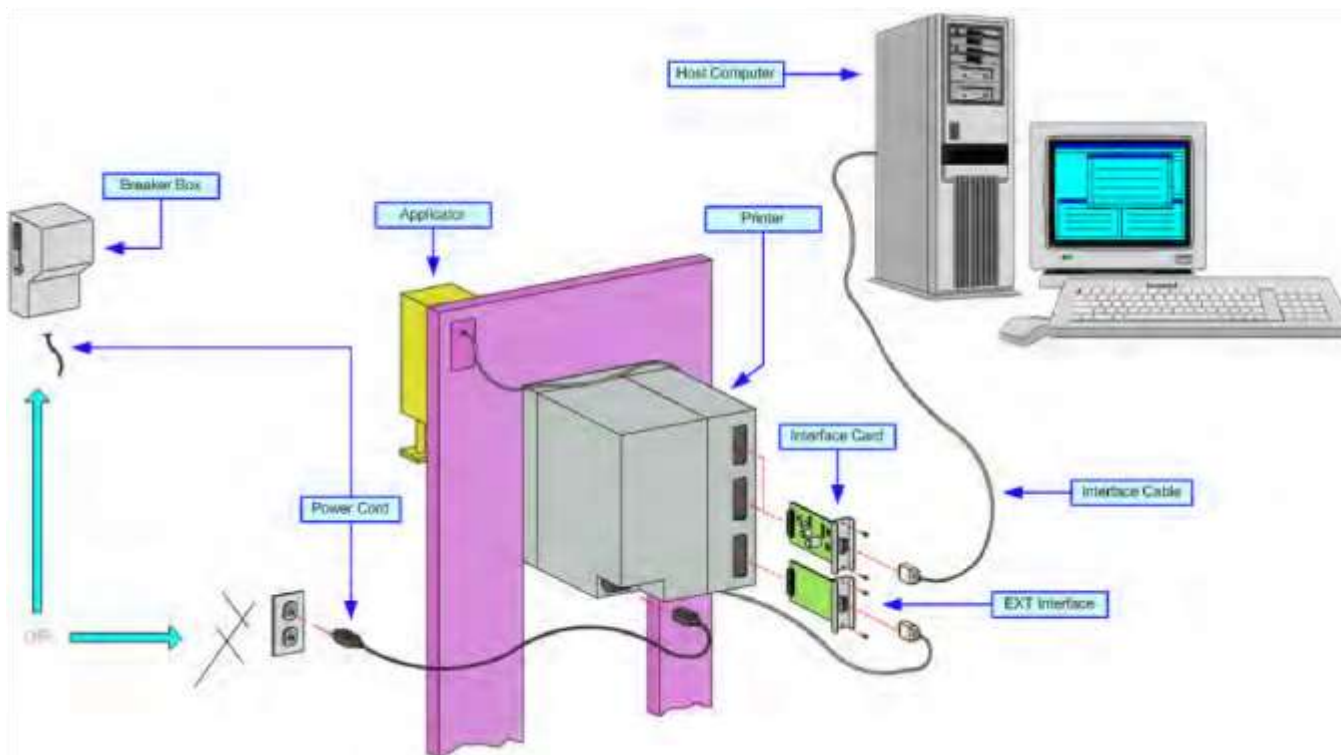

Figure 3-4, Printer Connection

ATTENTION: Figure 3-4 displays the printer interfaced with a host computer. However, the printer may also be interfaced with a PLC, keyboard, scanner, etc.

PRINTER LOADING

WARNING: AVOID PHYSICAL CONTACT WITH THE PRINT HEAD TO PREVENT BURNED FINGERS/HANDS AND COMPONENT DAMAGE.

MEDIA SELECTION

The size and type of labels to be printed should have been taken into consideration before printer purchase. Ideally, the media width will be equal to, or just narrower than, the print head. Using media that does not cover the print head will allow the platen roller to tread upon its surface resulting in premature wear. The media edge will also wear a groove in the platen roller affecting print quality.

There are two types of media that may be used: thermal transfer and direct thermal. Thermal transfer media requires the use of ribbon stock for print application. In such a scenario, it is the ribbon stock (carbon paper) that contains the ink that will be transferred to the media.

Direct thermal media has thermally reactive material embedded within and is brought to the surface through heat penetration by print head contact. Only load ribbon stock into the printer if that media type is to be used.

MEDIA LOADING

To load label media, unlatch the print head and remove any remnants that may exist of the prior media supply. Feed the free end of the media from the printer's left side, beneath the shaft of the media guide, between the upper and lower halves of the label sensor, across the top of all forthcoming rollers, and through to protrude six or more inches beyond the printer chassis.

Ensure the media is flush against the printer's back side (toward the center wall) and then adjust the media guide inward until it almost makes contact with the media's backing paper.

Remove all labels from the backing paper that extend beyond the printer chassis and re latch the print head.

Lift upward on the pressure roller release knob (purple) and allow the pressure roller plate to fall to a vertical position. Route the backing paper's free end around the front of the printer chassis, beneath the front platen roller and onward between the second platen roller and the pressure roller. Pull the free end of the backing paper to remove all slack while lifting the pressure plate until latched. Refer to Figure 3-5 for visual assistance.

NOTE: Properly installed label media will be oriented so that the label side is upward and the backing paper is downward resting upon the printer chassis.

NOTE: Refer to the Printer Configuration unit of this manual for media configuration instructions. Refer to the Adjustment Procedures section of the Maintenance unit for label sensor adjustment instructions as necessary.

RIBBON LOADING

To load ribbon stock, unlatch the print head and remove exhausted ribbon stock if applicable. Insert an unused ribbon roll, with ribbon core, fully onto the ribbon supply boss (left) and an empty core onto the ribbon rewind boss (right). Route the ribbon's free end around the print assembly and tape it to the blank core on the rewind boss. Rotate the core a couple of times while holding the boss stationary to take up take up slack. Refer to Figure 3-5 for visual assistance.

NOTE: Properly installed ribbon stock will be oriented so that its dull, ink side is facing the printer chassis while the ribbon is dispensed and taken up on the right side of each roll. The non-ink side of the ribbon stock is the shinier of the two surfaces.

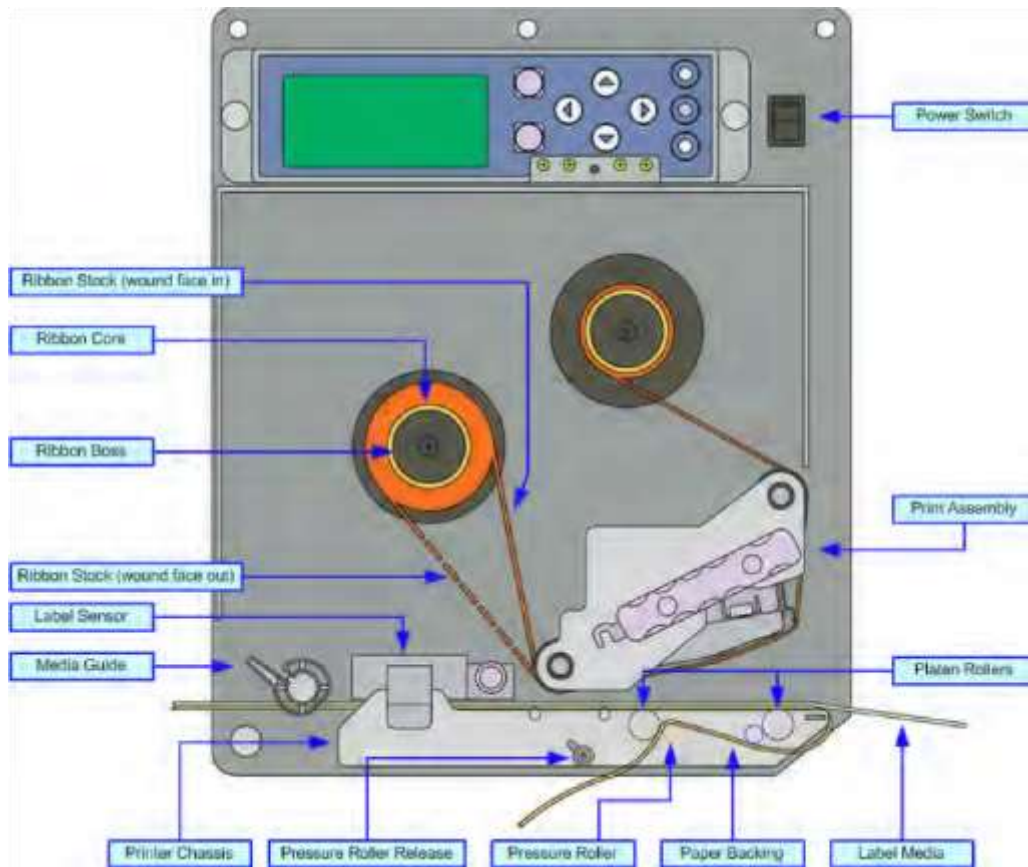

Figure 3-5, Ribbon & Media Loading

OPERATIONAL MODE SELECTION

There are two modes of printer operation: Dispense or Continuous. The difference between the two is the way that the label and paper backing is ejected. Before printer configuration, one must determine which mode will be used. This chapter identifies and defines the functional differences between the two.

DISPENSE MODE

With this method of operation, after printing, the printer feeds the first (outermost) label so that it is fully extended out of the printer's front for dispensing. Printing of the next label will not begin until the prior printed label has

been removed. This mode of operation is specifically suited for the use of automated machinery to remove the printed and dispensed label to apply to packaging, etc.

Upon removal of the prior printed label, the printer repositions the media so that the next label in line may be printed, then prints. The before-mentioned cycle, repeats for each consecutive label.

Printer configuration for the backfeed function may be found in the Advanced Mode of the Configuration unit of this manual. Refer to the Table of Contents for the page number.

CONTINUOUS MODE

With this method of operation, the media remains in position for printing at all times. To do so, means that the previous printed label is never in proper position for dispensing and thusly, must be manually removed from the printer rather than through the application of automated machinery.

Printer configuration for Continuous mode of operation may be found in the Advanced Mode of the Configuration unit of this manual. Refer to the Table of Contents for the page number.

ATTENTION: Refer to the Printer Configuration unit of this manual to program the printer's internal memory to suit individual needs using the printer's integrated menu options. Refer to the Programming Reference document to remotely program the printer's features and functions through a host system.

INTERFACE SELECTION

This unit presents the printer interface types and their specifications. These specifications include detailed information to assist in the selection of the most appropriate method for the printer to interface with the host. The five acceptable interface methods are:

- RS232C High-Speed Serial
- IEEE1284 Parallel
- Universal Serial Bus (USB)
- Local Area network (LAN) Ethernet
- IEEE802.11b/g Wireless LAN

Following the selection of the desired interface, proceed to the next unit for instructions on how to configure the printer for that interface type.

WARNING: NEVER CONNECT OR DISCONNECT INTERFACE CABLES (OR USE A SWITCH BOX) WITH POWER APPLIED TO EITHER THE HOST OR THE PRINTER. THIS MAY CAUSE DAMAGE TO THE INTERFACE CIRCUITRY IN THE PRINTER/HOST, AND IT IS NOT COVERED BY WARRANTY.

NOTE: Some hosts monitor the Request-To-Send (RTS) signal (pin 4 of 25) to determine if the printer is ready to receive data. Since the printer does not generate this signal, the RTS line must be held true (high) in order to allow communication. This can be performed by connecting the RTS pin to the Clear-To-Send (CTS) signal (pin 5 of 25).

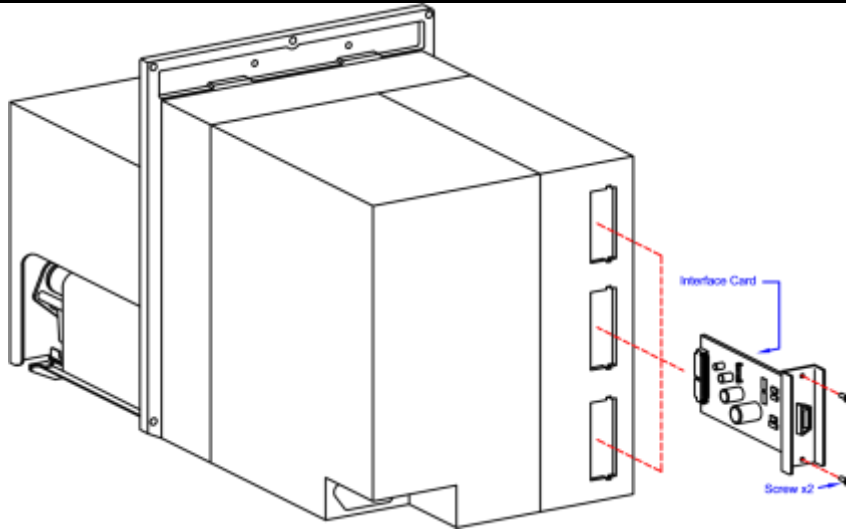

Figure 3-6, Interface Installation

RS232C HIGH-SPEED SERIAL INTERFACE

This High Speed Serial Interface is a Plug-In Interface Module that can be installed in the printer by the user.

INTERFACE SPECIFICATIONS	
Asynchronous ASCII	Half-duplex communication Bi-Directional Communication
Data Transmission Rate	2400 *, 4800 *, 9600, 19200, 38400, 57600 bps
Transmission Form	Start, b1, b2, b3, b4, b5, b6, b7, b8, Stop (b8 will be omitted if using 7 bit oriented)
Data Length	7 or 8 bit (selectable)
Stop Bit	1 or 2 bit (selectable)
Parity Bit	ODD, EVEN, NONE (selectable)
Codes Used	ASC II Character Codes: 7 bits, Graphics: 8 bits
Control Codes	STX (02H), ETX (03H), ACK (06H), NAK (15H)
Connector (Printer Side)	DB-25S Male (equivalent)
Cable Connector	DB-25P Female (equivalent)
Cable Length	5 meters or fewer.
Signal Levels	High = +5V to +12V, Low = -5V to -12V
Protocol	Ready/Busy, X-On/X-Off, Status3, Status4, Status5 **; When Compatible Mode is ON: Status2.

* Baud rate of 2400bps and 4800bps can be set in Interface Mode.

** Status5 can be set in Interface Mode.

DIP SWITCH SETTINGS		
SWITCH	COMPONENT	SETTINGS

Unit 3: Installation

1	Data Bit	ON		7 Bits
		OFF		8 Bits
2 & 3	Parity	2	3	
		ON	ON	Reserved
		ON	OFF	ODD
		OFF	ON	EVEN
		OFF	OFF	NONE
4	Stop Bit	ON		2 Bits
		OFF		1 Bit
5 & 6	Baud Rate	5	6	
		ON	ON	57600 bps
		ON	OFF	38400 bps
		OFF	ON	19200 bps
		OFF	OFF	9600 bps
7 & 8	Protocol	7	8	
		ON	ON	STATUS4 (When Compatible Mode is ON: Status2)
		ON	OFF	STATUS3
		OFF	ON	X-ON/X-OFF
		OFF	OFF	Ready/Busy

- When READY/BUSY and XON/XOFF are set, single-item buffer or multi buffer can be set in the Interface Mode. Settings of Compatible Mode can be made in Service Mode.

READY/BUSY INTERFACE SIGNALS		
PIN	DIRECTION	SIGNAL DEFINITION
1	Reference	FG (Frame Ground)
2	To Host	TD (Transmit Data) - Data from the printer to the host computer. Sends X-On/X-Off characters or status data (bi-directional protocols).
3	To Printer	RD (Receive Data) - Data to the printer from the host computer.
4	To Host	RTS (Request to Send) - Used with Ready/Busy flow control to indicate an error condition. RTS is high and remains high unless the print head is open (in this case, RTS would return to the high state after the print head is closed and the printer is placed back on-line) or an error condition occurs during printing (e.g., ribbon out, label out).
5	To Printer	CTS (Clear to Send) - When this line is high, the printer assumes that data is ready to be transmitted. The printer will not receive data when this line is low. If this line is not being used, it should be tied high (to pin 4).
6	To Printer	DSR (Data Set Ready) - When this line is high, the printer will be ready to receive data. This line must be high before data is transmitted. If this line is not being used, it should be tied high (to pin 20).
7	Reference	SG (Signal Ground)
20	To Host	DTR (Data Terminally Ready) - This signal applies to Ready/Busy flow control. The printer is ready to receive data when this pin is high. It goes low when the printer is offline, either manually or due to an error condition, and while printing in the single job buffer mode. It will also go low when the data in the buffer reaches the buffer near full level.

READY/BUSY CABLE REQUIREMENTS					
DB9	DB25	HOST	DIRECTION	DB25	PRINTER
1	1	FG (Frame Ground)	Bi-Directional	1	FG (Frame Ground)
2	3	RD (Receive Data)	To Host	2	TD (Transmit Data)
3	2	TD (Transmit Data)	To Printer	3	RD (Receive Data)
8	5	CTS (Clear To Send)	To Printer DB9-6	4	RTS (Request To Send)
4	20	DTR (Data Terminal Ready)	To Printer DB9-4	5	DSR (Data Set Ready)
6	6	DSR* (Data Set Ready)	To Host	6	DTR (Data Terminal Ready)
5	7	SG (Signal Ground)	Bi-Directional	7	SG (Signal Ground)

* This connection at the host side of the interface would depend upon the pin that is being used as the Ready/Busy signal by the driving software. Typically, on a PC, it would be either CTS (pin5) or DSR (pin 6) on a DB-25 connector.

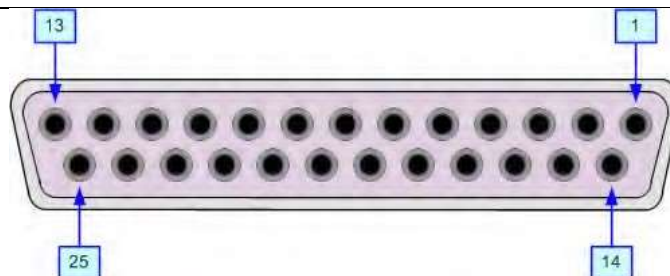

Figure 3-7, Serial Connector Pin Assignments

X-ON/X-OFF CABLE REQUIREMENTS

Communicates with the host to determine if the printer is ready to receive data by sending "XON" (HEX 11H) or "XOFF" (HEX 13H) code to the TD line. The single and multiple item buffers are switchable in the Interface Mode of the printer.

DB9	DB25	HOST	DIRECTION	DB25	PRINTER
1	1	FG (Frame Ground)	Bi-Directional	1	FG (Frame Ground)
2	3	RD (Receive Data)	To Host	2	TD (Transmit Data)
3	2	TD (Transmit Data)	To Printer	3	RD (Receive Data)
5	7	SG (Signal Ground)	Bi-Directional	7	SG (Signal Ground)

NOTE: Depending on the host used, it may be required to loop CS and RS (maintaining at high-level) on the host side. For more information, refer to the host computer documentation.

NOTE: Refer to the charts & diagrams section of this chapter to view timing charts for Ready/Busy and X-ON/X-OFF.

IEEE1284 PARALLEL INTERFACE

The parallel interface is a plug-in module that can be installed by the user and conforms to IEEE1284 specifications. It automatically detects the IEEE1284 signals and operates in the high speed mode. If the IEEE1284 signals are not detected, it will operate in the slower standard Centronics mode. For this reason, an interface cable and host interface conforming to the IEEE1284 specification must be present to fully utilize the speed capabilities. This interface also operates bi-directionally and can report the status of the printer back to the host.

SPECIFICATIONS	
Printer Connector	AMP 57-40360 DDK (or equivalent)
Cable Connector	AMP 57-30360 DDK (or equivalent)
Cable	1.5 meter or less
Signal Level	High = +2.4V to +5.0V, Low = 0V to +0.4V
Data Stream	<ESC>A . . Job#1 . . <ESC>Z<ESC>A . . Job#n . . <ESC>Z

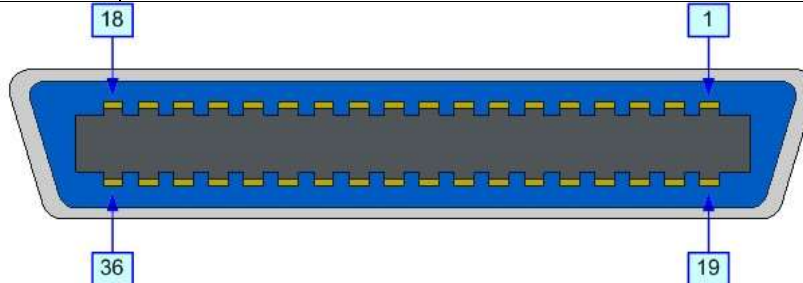

Figure 3-8, Parallel Connector Pin Assignments

PIN ASSIGNMENTS					
PIN	SIGNAL	DIRECTION	PIN	SIGNAL	DIRECTION
1	FG (Frame Ground)	Bi-Directional	1	FG (Frame Ground)	Bi-Directional
2	RD (Receive Data)	To Host	2	TD (Transmit Data)	To Printer
3	TD (Transmit Data)	To Printer	3	RD (Receive Data)	To Host
5	SG (Signal Ground)	Bi-Directional	7	SG (Signal Ground)	Bi-Directional

Unit 3: Installation

1	Strobe	To Printer	19	Strobe Return	Reference
2	Data 1	To Printer	20	Data 1 Return	Reference
3	Data 2	To Printer	21	Data 2 Return	Reference
4	Data 3	To Printer	22	Data 3 Return	Reference
5	Data 4	To Printer	23	Data 4 Return	Reference
6	Data 5	To Printer	24	Data 5 Return	Reference
7	Data 6	To Printer	25	Data 6 Return	Reference
8	Data 7	To Printer	26	Data 7 Return	Reference
9	Data 8	To Printer	27	Data 8 Return	Reference
10	ACK	To Host	28	ACK Return	Reference
11	Busy	To Host	29	Busy Return	Reference
12	Ptr Error	To Host	30	PE Return	Reference
13	Select	To Host	31	INIT	To Printer
14	AutoFD1	To Printer	32	Fault	To Host
15	Not Used		33	Not Used	
16	Logic Gnd		34	Not Used	
17	FG	Frame Gnd	35	Not Used	
18	Peripheral Logic High	To Printer	36	SelectIn1	From Host
<i>1 Signals required for IEEE 1284 mode.</i>					

UNIVERSAL SERIAL BUS (USB)

The Universal Serial Bus (USB) interface is a Plug-In Interface Module that can be installed by the user. It requires a driver (shipped with each printer that has the interface installed) that must be loaded onto the PC and configured to support USB peripherals using Windows 2000 or above. Details for loading the USB driver are contained in the USB Interface Manual that is shipped with each printer with a USB Optional interface installed. Up to 127 devices may be connected to a USB port using powered hubs.

ATTENTION: This Interface Type Is Not Compatible With Windows 98 Or Windows Me.

SPECIFICATIONS	
Printer Connector	USB Type B Plug

Unit 3: Installation

Cable	6.56 feet (2 m) maximum
Host	Windows 2000 or above with USB Port
Power Supply	BUS Power through cable

LOCAL AREA NETWORK (LAN) ETHERNET

A Local Area Network (LAN) interface is an optional Plug-In Interface Module that can be installed by the user. It requires a driver shipped with each printer that has the interface installed. The driver that must be loaded onto the host computer and configured to run one of the supported network protocols using a 10Base-T or 100Base-TX LAN connection. Details for loading the LAN driver are contained in the LAN Interface Manual that is shipped with each printer with a LAN Optional interface installed.

SPECIFICATIONS

Connector	RJ-45 Receptacle
Cable	10BASE-T, 100BASE-TX
Cable Length	100 meters or less
Power Supply	Powered from printer
Protocol	Status3 return Status4 (cyclic response mode) Status4 (ENQ response mode) Status4 return Status5 return
IP Address	0.0.0.0 to 255.255.255.255
Subnet Mask	0.0.0.0 to 255.255.255.255
Gateway Address	0.0.0.0 to 255.255.255.255

DIP SWITCH SETTINGS

SWITCH	SETTING
1	Reserved (setup prohibited).
2	LAN board EEPROM initialization (configuration).
3	Print configuration details on a label.
4	Print a self-diagnosis of the board onto a label.

SOFTWARE SPECIFICATIONS

Corresponding Protocol	TCP/IP
Network Layer	ARP, RARP, IP, ICMP
Session Layer	TCP, UDP
Application Layer	LPD, FTP, TELNET, BOOTP, DHCP

NOTE: Print data can be sent by LPR and FTP of TCP/IP and dedicated socket protocol. Printer status is obtainable by dedicated socket protocol.

NOTE: In the TCP/IP protocol environment, LPD and FTP are provided for printing; TELNET for variable setup; ARP, RARP, and BOOTP/DHCP for address setup.

Unit 3: Installation

LPD protocol complies with RFC1179 and handles the list of logical printer name as queue name such as lp, sjis, euc. In addition, a banner page can be printed by a proper setup.

When sending the job by LPR, the transmission order of data file/control file within the job will not affect print operation. In addition, if the banner page is specified, it will be added to each data file. Job deletion by LPR is not available.

FTP protocol complies with RFC959 and handles the list of logical printer name as a transfer directory. File transfer to this directory executes print operation. It is possible to specify ASCII(A), Binary(I) and TENEX(L8) as transfer mode - although the mode difference is dependent on the client. A banner page may be printed with a proper setup.

TELNET Complies with RFC854. This operation consists of interactive menu form and enables change and reference of internal setup, and to display status. To change the setup, enter "root" user and password at the time of login. Default of root password is set as null (linefeed only).

802.11G WIRELESS

The wireless print server provides easy printer interface with 802.11g Wi-Fi compliant networks free of wired connections. Each printer is shipped with an integrated driver and interface installed. The driver must be loaded onto the host computer and configured to run one of the supported protocols.

SPECIFICATIONS

Variable Data Rates	54, 11, 5.5, 2 and 1 Mbps
Frequency Band	2.4 GHz ISM Band
Wired Equivalent Privacy	128 bit, 64 bit (compatible with 40bit), none (WPA)
Sensitivity	(typ, AAWGN, 8E-2 PER): -91dBm at 1Mbps, -88dBm at 2 Mdps, -87dBm at 5.5Mbps, 84dBm at 11Mbps.
Range	100m indoors, 300m outdoors (environmentally dependent)
Protocols	TCP/IP, IPX/SPX, Direct Mode IPX/IP, DLC/LLC, NetBEUI, NetBIOS/IP
Protocol	Status3 return Status4 (cyclic response mode) Status4 (ENQ response mode) Status4 return Status5 return
IP Address	0.0.0.0 to 255.255.255.255
Subnet Mask	0.0.0.0 to 255.255.255.255
Gateway Address	0.0.0.0 to 255.255.255.255
Communication Mode	802.11 Ad hoc, Ad hoc, Infrastructure
SSID	Optional alphanumeric character string (up to 32 characters)
Channels	01 to 14

DIP SWITCH SETTINGS

The DIP switches serve to initialize the configuration saved on the Wireless-LAN board, print the configuration, and make a self-diagnosis. To communicate with the host, set the communication mode by through switches 5 and 6, then set the remaining switches to the OFF position.

Print of configuration and self-diagnosis are operable only on the screen after turning on the printer. Ensure all switches are in the OFF position when operating the printer.

SWITCH	SETTING	
1	OFF	Normal operating setting.
2	OFF	Normal operating setting.
	ON	Initialization/Reset to factory default upon power up.

Unit 3: Installation

3	OFF	Normal operating setting.
	ON	Configuration report upon power up - prints diagnostic report upon powering up.
4	OFF	Wireless Mode setting.
	ON	

NOTE: The communication mode may be set within the printer's Interface Mode. Go to [Communication] of the Interface Mode to enable setup by either the DIP switches or through the Interface Mode.

WIRELESS LAN SIGNAL STRENGTH

Network Port	Link LED	Off	0 to 50% (weak)
		Blinking	50 to 75% (medium)
		On	75 to 100% (strong)

LED INDICATOR STATUS

Link LED (green)	Network Port	Off	---
	Front Panel	Blinking	Waiting for link
		On	Linked
Status LED (orange)	Network Port	Off	---
	Front Panel	Blinking	Receiving packet
Wireless LED (green)	Front Panel	Blinking	Ad-hoc mode
		On	Infrastructure mode

SOFTWARE SPECIFICATIONS

Corresponding Protocol	TCP/IP
Network Layer	ARP, RARP, IP, ICMP
Session Layer	TCP, UDP
Application Layer	LPD, FTP, TELNET, BOOTP, DHCP

NOTE: Print data can be sent by LPR and FTP of TCP/IP and dedicated socket protocol. Printer status is obtainable by dedicated socket protocol.

NOTE: In the TCP/IP protocol environment, LPD and FTP are provided for printing; TELNET for variable setup; ARP, RARP, and BOOTP/DHCP for address setup.

LPD protocol complies with RFC1179 and handles the list of logical printer name as queue name such as lp, sjis, euc. In addition, a banner page can be printed by a proper setup.

When sending the job by LPR, the transmission order of data file/control file within the job will not affect print operation. In addition, if the banner page is specified, it will be added to each data file. Job deletion by LPR is not available.

FTP protocol complies with RFC959 and handles the list of logical printer name as a transfer directory. File transfer to this directory executes print operation. It is possible to specify ASCII(A), Binary(I) and TENEX(L8) as transfer mode - although the mode difference is dependent on the client. A banner page may be printed with a proper setup.

TELNET Complies with RFC854. This operation consists of interactive menu form and enables change and reference of internal setup, and to display status. To change the setup, enter "root" user and password at the time of login. Default of root password is set as null (linefeed only).

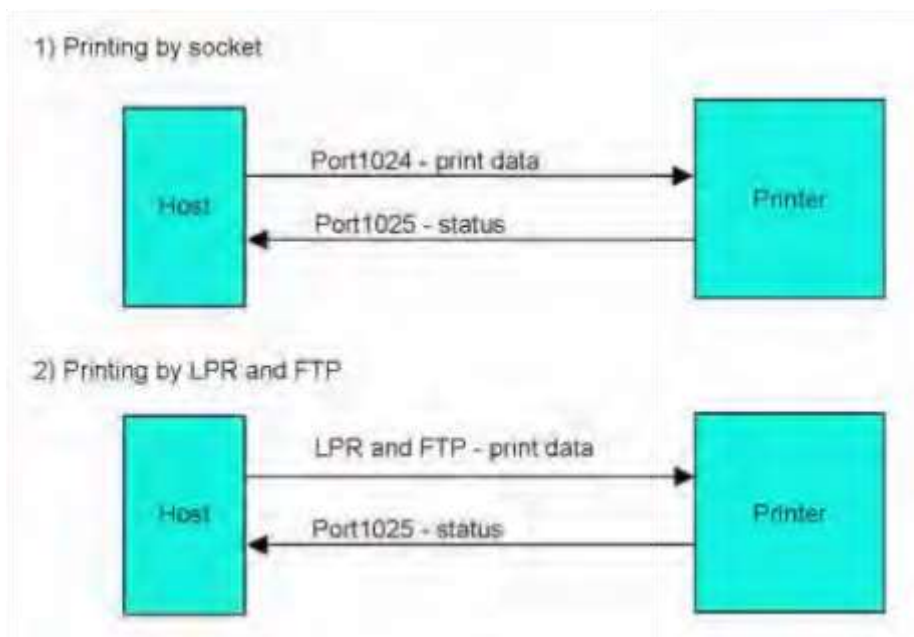

Figure 3-9, Socket Connection Diagram

ALL INTERFACES

RECEIVE BUFFER

The data stream is received from the host to the printer one job at a time. This allows the software program to maintain control of the job print queue so that it can move a high priority job in front of ones of lesser importance. A multiple job buffer allows the printer to continuously receive print jobs while compiling and printing other jobs at the same time. It acts much like a Print buffer to maximize the performance of the host and the printer.

The printer receives and prints one job at a time. If a print job exceeds the buffer size, transmission will be rejected by the printer. Error conditions that occur during the Print Data transmission will cause the printer to return a NAK.

ACK/NAK PROTOCOL

Bi-Directional ACK/NAK protocol is used for error control. In a normal transmission sequence when the transmission is received, the printer will return an ACK (06H) signifying that it was received without a transmission error. After the transmission command structure has been analyzed, a status byte is returned to the host. This status byte informs the host of the validity of the command structure.

If the command structure is error free, the printer proceeds with the print operation. When the print operation is completed, a Printer Status message is returned to the host. If an error was detected during the initial transmission sequence, a NAK (15H) will be returned signalling to the host that the received transmission contained errors and must be resent. If the returned Status byte indicates a command structure error, the error must then be corrected before the print data is resent to the printer.

A valid transmission to the printer must be bounded by an STX/ETX pair, with the STX (02H) signifying the start of the Print Data and ending with an ETX (03H) signifying the end.

STATUS5 RETURN

This communication protocol is designed for the purpose of monitoring and controlling print data status in the host and featuring various functions.

INTERFACE SIGNALS		
PIN	DIRECTION	SIGNAL DEFINITION
1	Reference	FG (Frame Ground)
2	To Host	TD (Transmit Data) - Data from the printer to the host computer.
3	To Printer	RD (Receive Data) - Data to the printer from the host computer.
7	Reference	SG (Signal Ground)

CABLE REQUIREMENTS					
Depending on the host used, it may need to loop CS and RS (maintaining at high level) on the host side. For additional information, refer to the host computer documentation.					
DB 9	DB25	HOST	DIRECTION	DB25	PRINTER
1	1	FG (Frame Ground)	Bi-Directional	1	FG (Frame Ground)
2	3	RD (Receive Data)	To Host	2	TD (Transmit Data)
3	2	TD (Transmit Data)	To Printer	3	RD (Receive Data)
5	7	SG (Signal Ground)	Bi-Directional	7	SG (Signal Ground)

RECEIVE BUFFER CONTROL	
Causes For Receive Buffer Near Full	Receive buffer near full occurs when the remaining free space of the buffer drops to 0.95MB of 2.95MB capacity or when the remaining free space is available for storing 50 of 500 items in the history buffer.
Release Of Receive Buffer Near Full	Receive buffer near full can be released when the remaining free space rises to 1.95MB or when the remaining free space is available for storing 200 items in the history buffer.

STATUS5 TIMING CHARTS

NORMAL PROCESS

(Figure 3-10a)

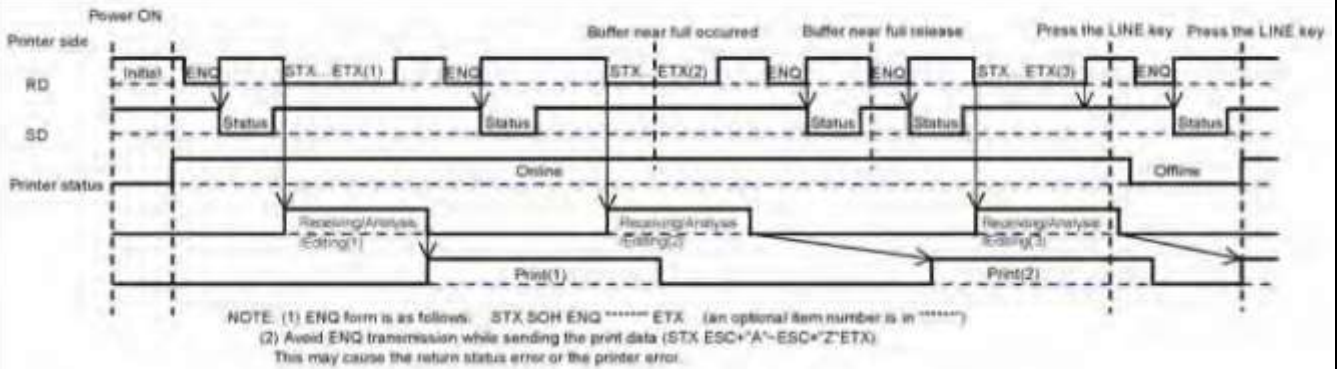

CANCEL PROCESS

(Figure 3-10b)

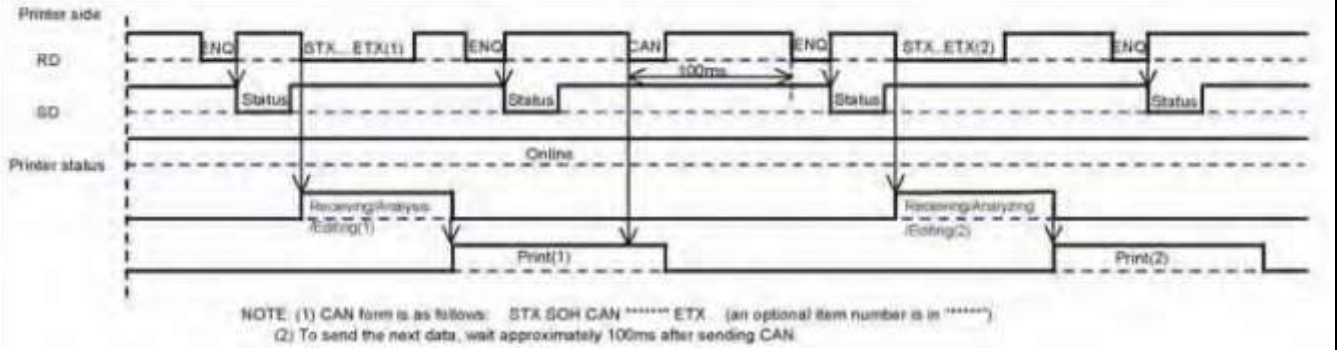

ERROR PROCESS

(Figure 3-10c)

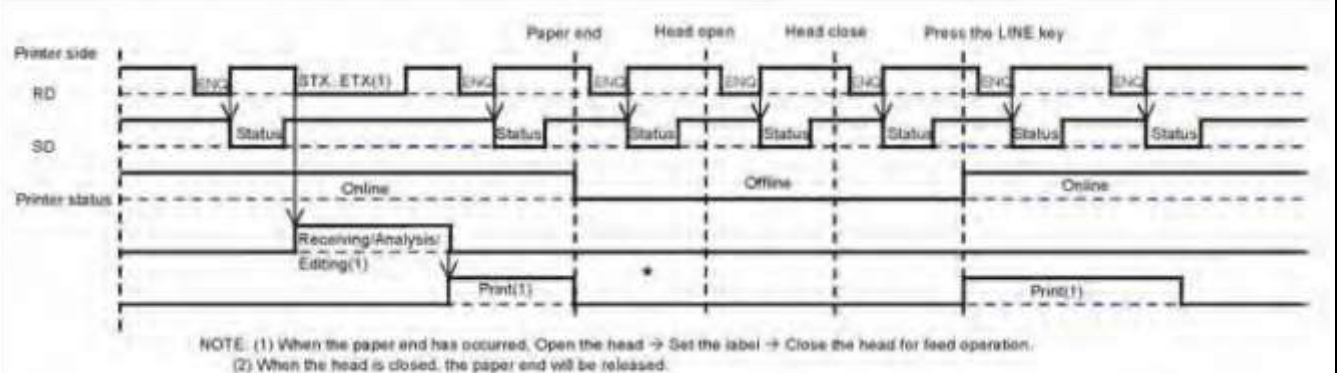

PRINT PROCESS

STATUS5 TIMING CHARTS

(Figure 3-10d)

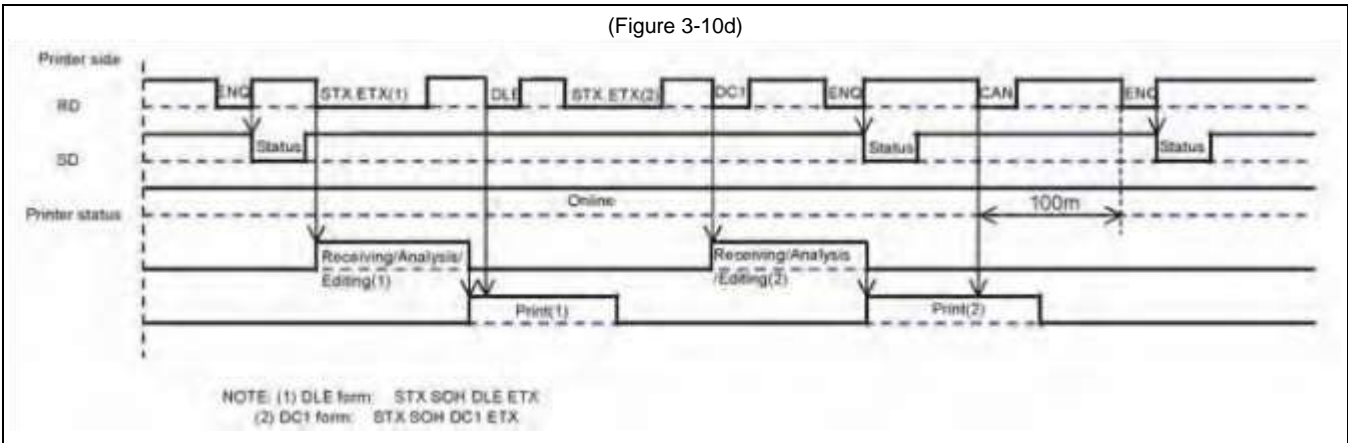

COMMAND PROCESS

(Figure 3-10e)

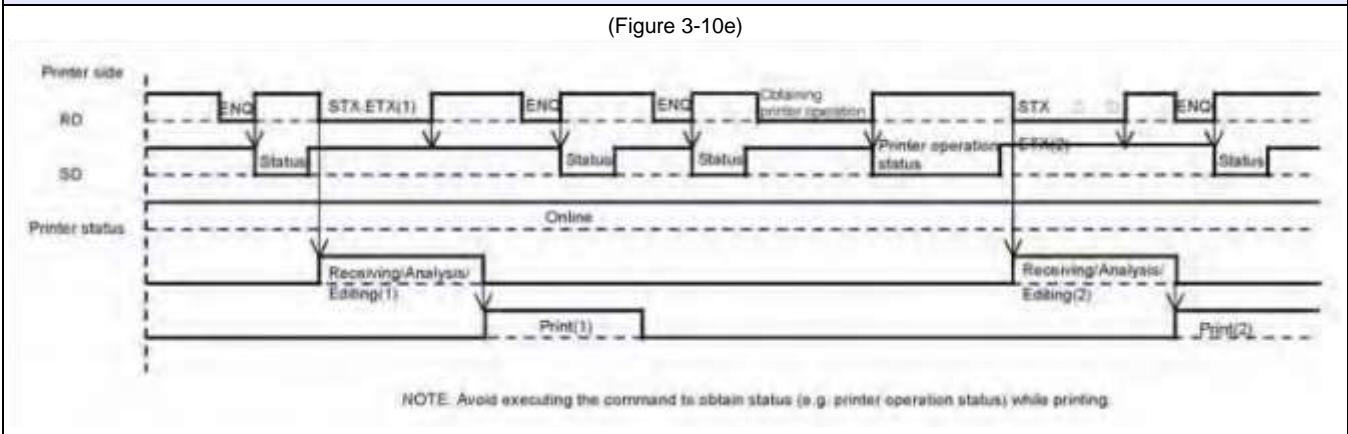

BCC ERROR PROCESS

(Figure 3-10f)

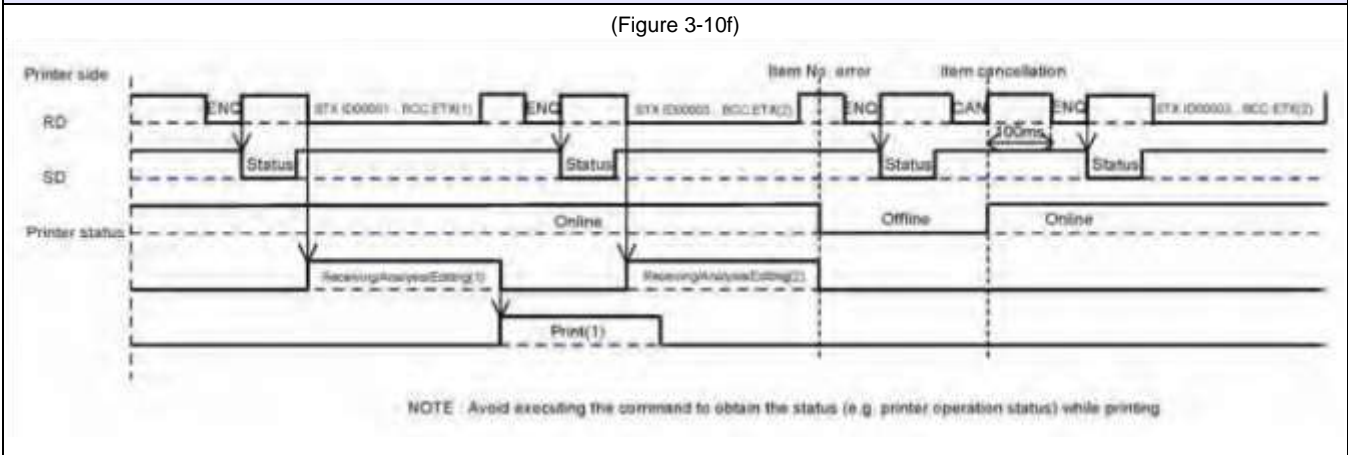

EXTERNAL SIGNAL

The external signal interface is designed to connect the printer to an applicator. Proceed to the printer's Advanced Mode for various setup activities related to the external signal.

There are two connector types available for the external signal interface, one with a 14-pin connector and the other with a 25-pin connector.

SPECIFICATIONS

Unit 3: Installation

Signal Level	High: +2.4 to +5.0V, Low: +0.0 to +0.4V
Issuing/Reissuing EXT signal	Enable/Disable in the Advanced Mode.
Switching EXT signal	Switching jumper connector to enable +24V output by 24V and 27V power supplies. When using 24V power supply: Short IN 24V side by jumper connector When using 27V power supply: Short IN 27V side by jumper connector.
Signal Types	<p>Print end signal (PREND) is "high" before printing labels, "low" after completion of print, and "high" 20 milliseconds later.</p> <p>Print end signal (PREND) is "low" before printing labels, "high" after completion of print, and "low" 20 milliseconds later.</p> <p>Print end signal (PREND) is "high" before printing labels, "low" from start to end of print, and "high" upon completion of print.</p> <p>Print end signal (PREND) is "low" before printing labels, "high" from start to end of print, and "low" upon completion of print.</p>

14-PIN CONNECTOR ASSIGNMENTS

PIN	SIGNAL NAME	DIRECTION	LEVEL	MAX CURRENT
1	Paper End	Output	Low	5V, 400mA
2	Ground	--	--	--
3	Ribbon End	Output	High	5V, 400mA
4	Machine Error	Output	Low	5V, 400mA
5	Print Start (PRIN)	Input	Low	High: high impedance, Low: -15mA or more, 0V
6	Print End (PREND)	Output	Low	5V, 400mA
7	Reprint (PRIN2)	Input	Low	High: high impedance, Low: -15mA or more, 0V
8	EXT5V_IN	Input		5V
9	Online	Output	Low	5V, 400mA
10	Ribbon Near End	Output	Low	5V, 400mA
11	Label Feed	Input	Low	High: high impedance, Low: -15mA or more, 0V
12	+24V	--	--	--
13	+5V	--	--	--
14	FG	--	--	--

Choose from Type I to Type IV for PREND (the output signal for Pin 6).

Do not use PIN No. 12 and 13 to power external devices.

25-PIN CONNECTOR ASSIGNMENTS

PIN	SIGNAL NAME	DIRECTION	LEVEL	MAX CURRENT
1	Frame Ground	---	---	---
2	+5V	---	---	---
3	---	---	---	---
4	Machine Error	Output	Low	5V, 400mA
5	Print End (PREND)	Output	Low	5V, 400mA

Unit 3: Installation

6	Offline	Output	Low	5V, 400mA
7	---	---	---	---
8	Reprint (PRIN2)	Input	Low	High: high impedance, Low: -15mA or more, 0V
9	---	---	---	---
10	---	---	---	---
11	EXT_GND	---	---	---
12	+5V	---	---	---
13	+24V	---	---	---
14	GND	---	---	---
15	EXT_GND	---	---	---
16	Ribbon End	Output	High	5V, 400mA
17	Paper End	Output	Low	5V, 400mA
18	Ribbon Near End	Output	High	5V, 400mA
19	---	---	---	---
20	Print Start (PRIN)	Input	Low	High: high impedance, Low: -15mA or more, 0V
21	Label Feed	Input	Low	High: high impedance, Low: -15mA or more, 0V
22	---	---	---	---
23	---	---	---	---
24	EXT5V_IN	Input	---	5V
25	GND	---	---	---

Choose from Type I to Type IV for PREND (the output signal for Pin 5). PREND will not be output when the command is "0" in the cutter mode.

Connect EXT_GND (Pins 11, 15) to external equipment GND.

Supply EXT5V_IN (Pin 24) 5V from the external power supply.

Do not use PIN No. 12 and 13 to power external devices.

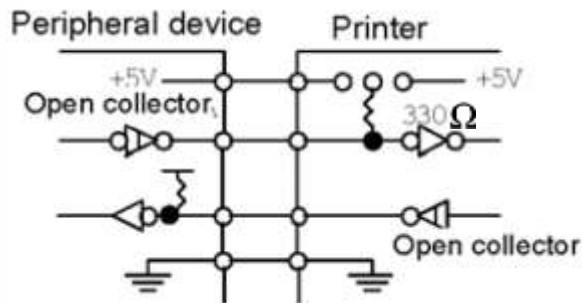

Figure 3-11, Input/Output Circuit Diagram

Unit 3: Installation

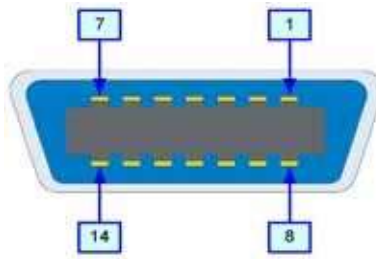

Figure 3-12, 14-Pin Connector Assignments

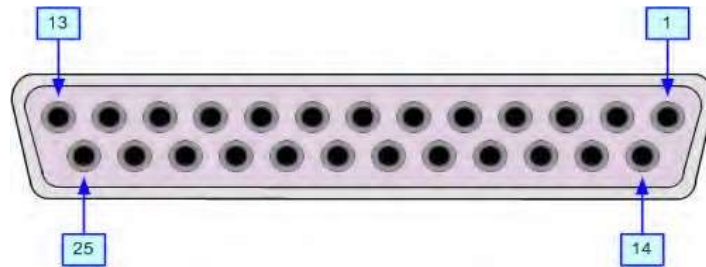
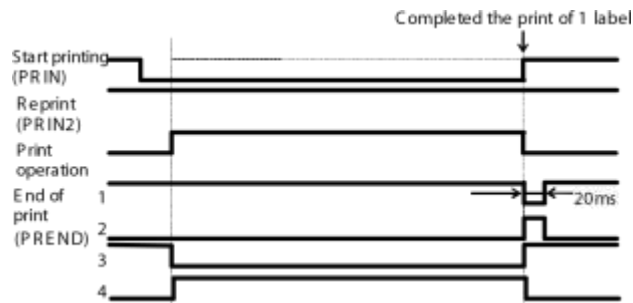

Figure 3-13, 25-Pin Connector Assignments

INPUT SIGNAL WAVE FORM

START PRINTING

(Figure 3-14a)



REPRINTING

(Figure 3-14b)

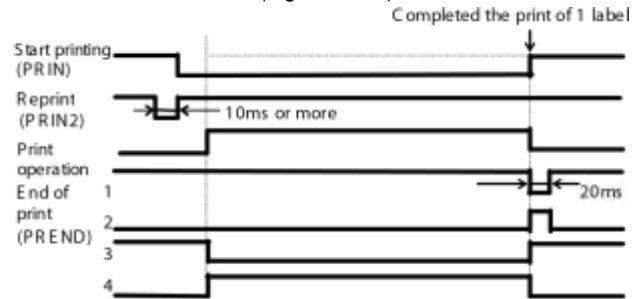

OUTPUT SIGNAL WAVE FORM

BASIC OPERATION

(Figure 3-15a)

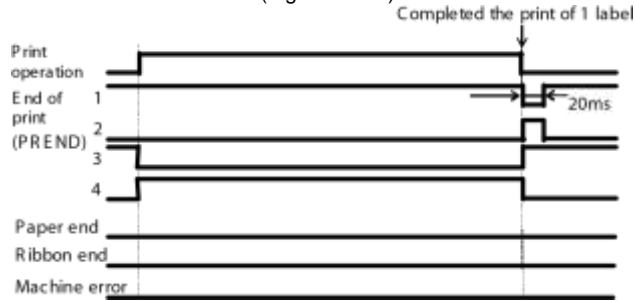

PAPER END

(Figure 3-15b)

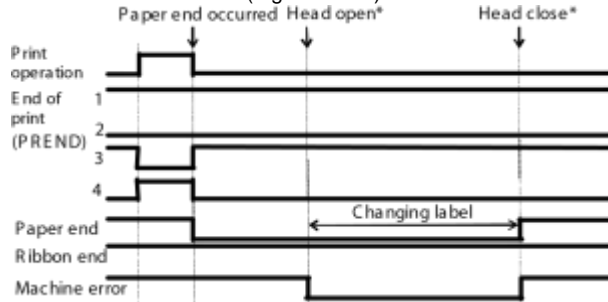

RIBBON END

(Figure 3-15c)

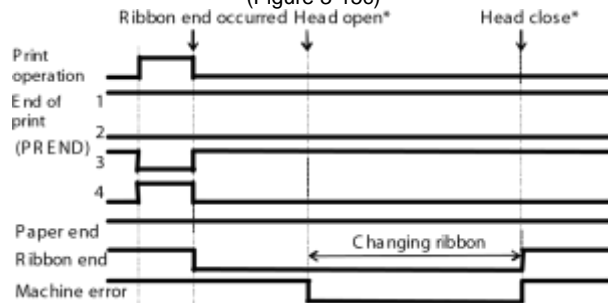

MACHINE ERROR

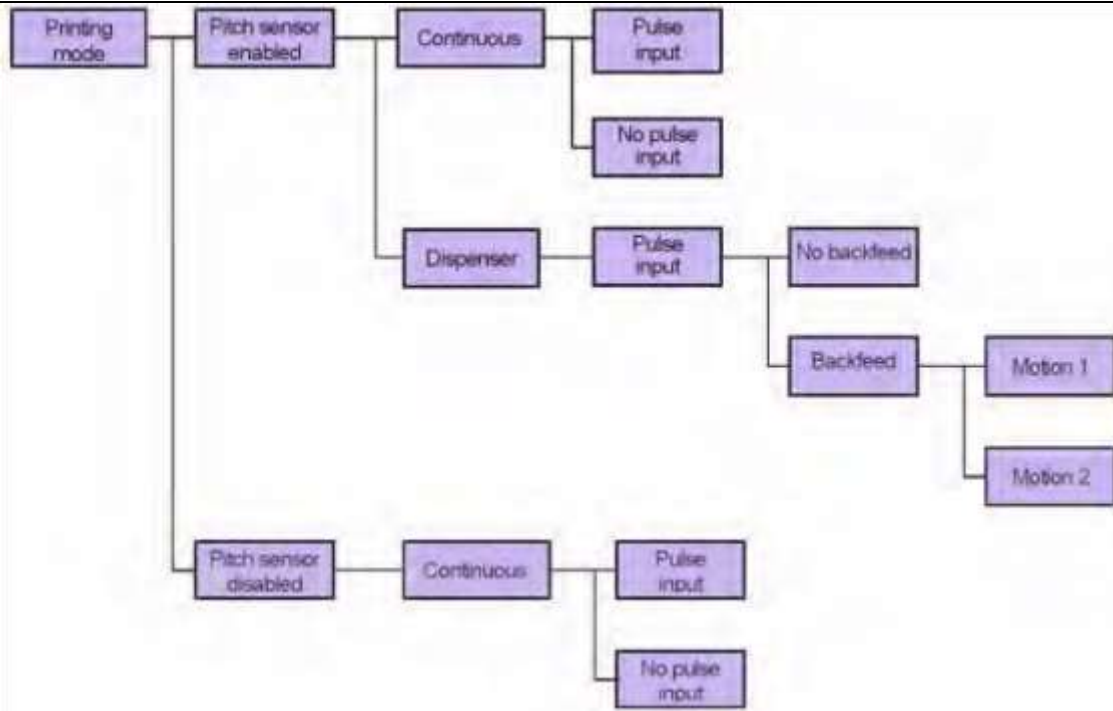
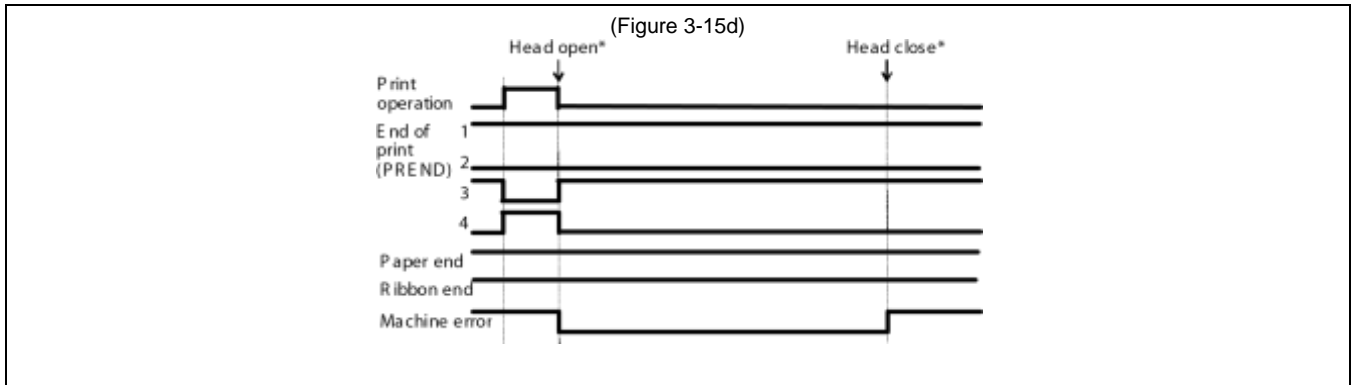

Figure 3-16, Operation Mode Flow Chart

ACCESSORIES INSTALLATION

This unit provides installation instructions of the purchase options available for this printer. These instructions only cover physical hardware installation. Refer to the Printer Configuration unit of this manual to configure the printer for their use.

INTERFACE INSTALLATION

The diagram below displays the physical installation of interface hardware. Refer to the Configuration unit of this manual for instructions on printer setup for the interface type chosen.

1. Switch off the printer (1, Figure 3-17) and follow applicable lockout-tagout procedures.
2. Remove interface slot covering (not shown) from printer (1) as applicable.
3. Insert chosen interface board (2) into its assigned slot and secure using two screws (3).

NOTE: The interface slot identified EXT is assigned for peripheral device connection. The center slot is assigned for standard interface card connection. And the remaining slot is not in use.

4. Repeat steps 2 and 3 for additional interface cards as applicable.

NOTE: Dependent on individual setup and operational requirements, multiple interface cards may be required.

5. Connect interface cable (not shown).

NOTE: The interface cable to be used is dependent upon the type of card and the device to be connected. Refer to this printer's operator manual for specific printer connection instructions. Refer to peripheral device's documentation for its connector identification.

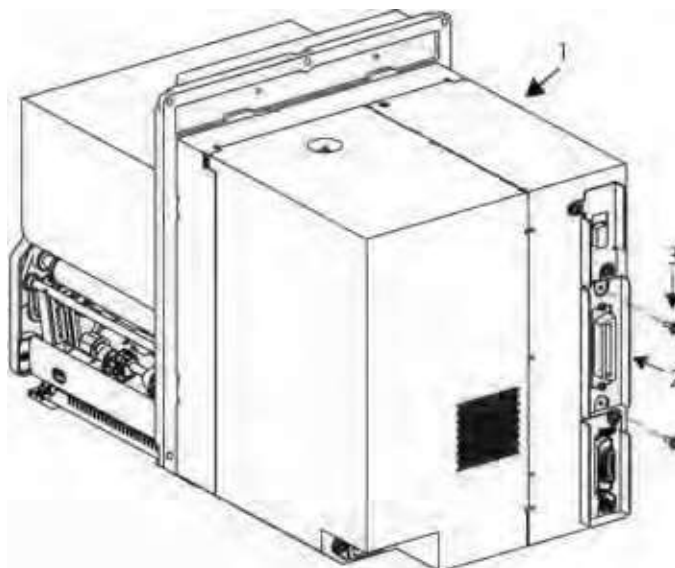

Figure 3-17, Interface Installation

REMOTE OPERATOR INTERFACE KIT

This purchase option allows the operator panel to be detached from the printer and secured in a remote location convenient for user access. Follow steps below to install the kit.

Installation Parts

Remote Operator Interface unit



Cable Tie



Screw M4 - 5 pieces



Installing the Kit

1. Remove the control panel from the printer.

Unit 3: Installation



2. Remove the panel base.



3. Assemble the interface unit in the control panel.

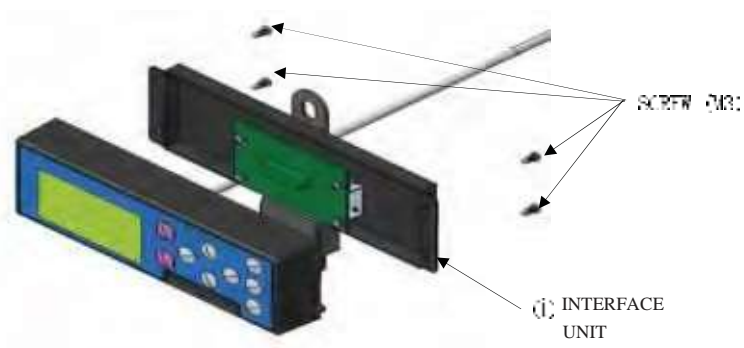

4. Assemble the interface unit in the main body of the printer.

Unit 3: Installation

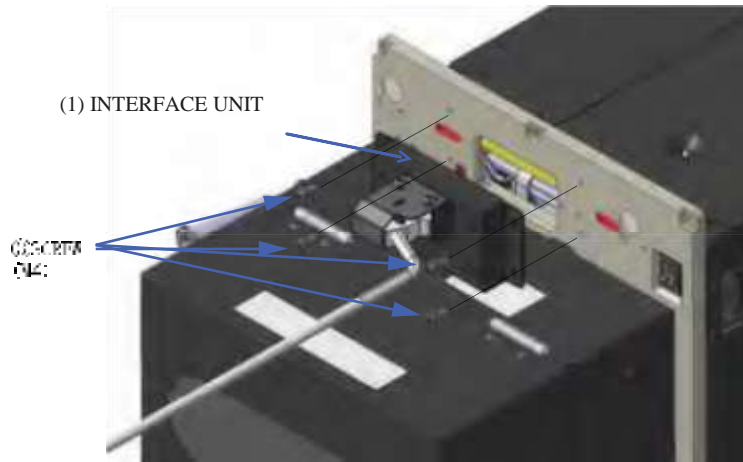

5. Connect the interface unit cable to the Cable Tie.

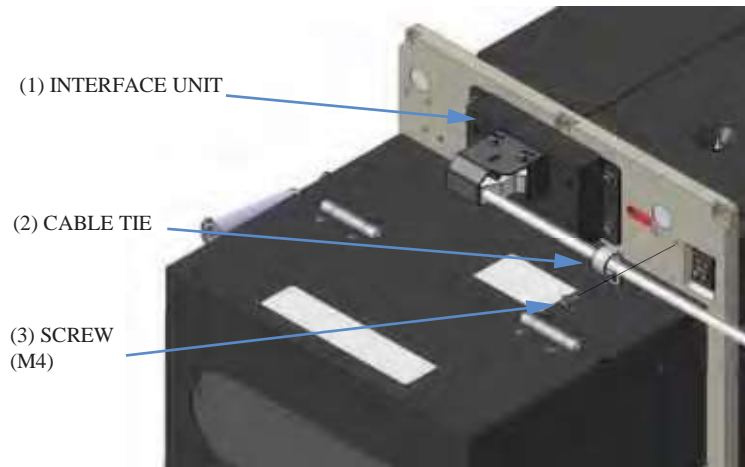

4

PRINTER CONFIGURATION

- **Printer Configuration**
- **Configuration Modes**
- **Menu Definition Tables**

PRINTER CONFIGURATION

This unit provides in-depth instruction on printer configuration for operation and for some troubleshooting.

The printer may be configured via the buttons and/or potentiometers located on the printer's operator panel. All of the printer's buttons, switches, and potentiometers are used singularly, or in conjunction, to perform configuration activities.

Refer to the Control Features chapter of the Introduction unit for identification of specific interface features.

CONFIGURATION MODES

This chapter provides an overview of the various configuration modes of the operation menu. All of the configuration activities are performed via the use of the operator panel located on the printer's face. However, many settings may also be controlled via external software commands. In the case of conflict between external software commands and internal software commands (control panel settings) the printer will always use the last valid setting, unless a priority function is provided via the LCD menu.

USER MODE

This mode allows configuration of printing features that are prone to change from job to job. These are some of the most basic and common adjustments of all of the configuration modes.

Use the keys of the printer's operator panel to select and enter the required options. Refer to the Menu Definition Tables in this chapter for an explanation of each menu screen.

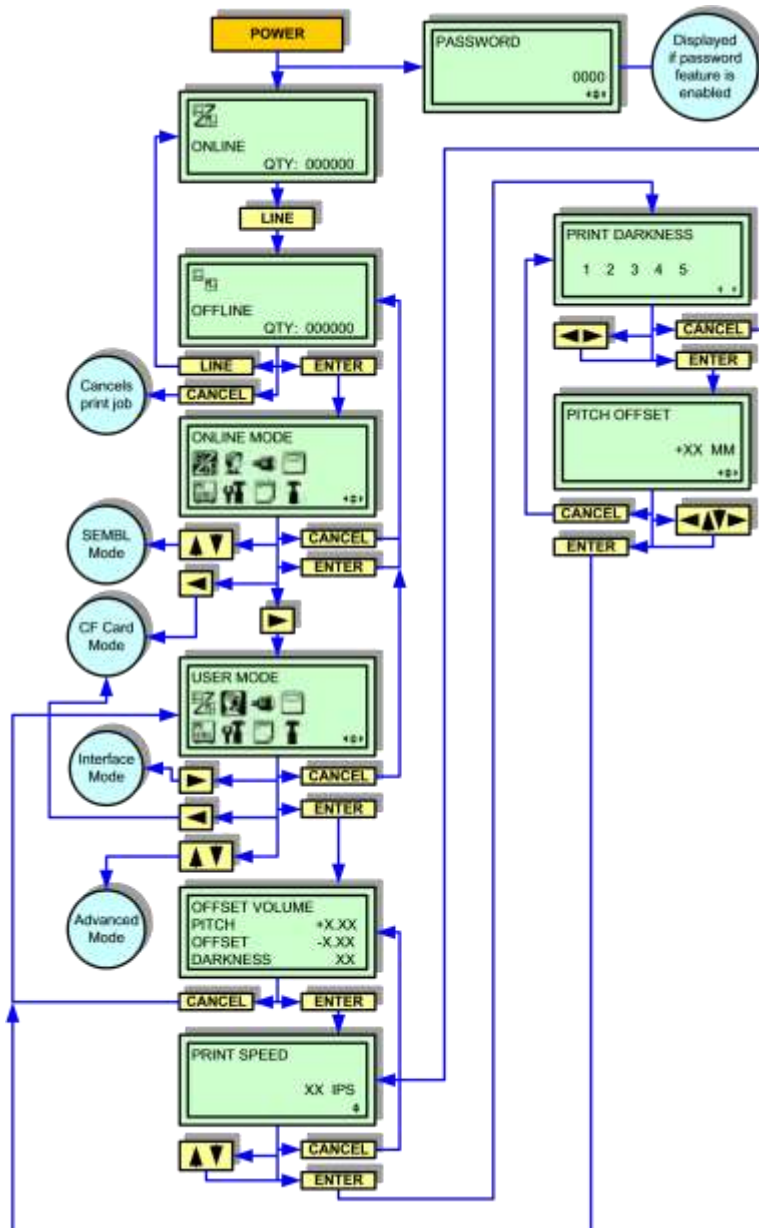

Figure 4-1, User Mode

ADVANCED MODE

The Advanced Mode is provided to make advanced printer operational adjustments. Typically, once these adjustments or settings have been made, they will not require additional address unless the application changes significantly.

Use the keys of the printer's operator panel to select and enter the required options. Refer to the Menu Definition Tables in this chapter for an explanation of each menu screen.

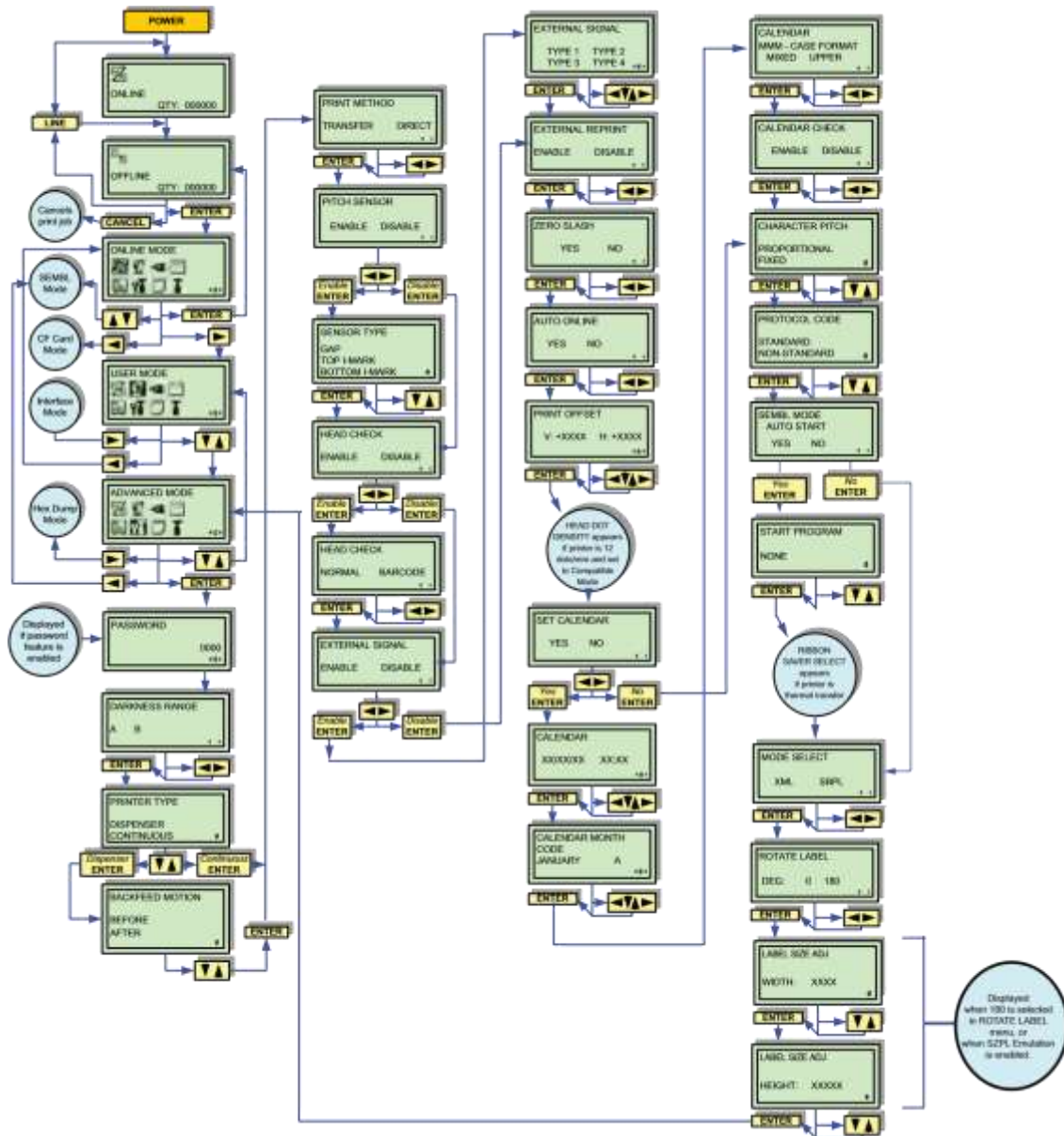

Figure 4-2, Advanced Mode

PARALLEL INTERFACE MODE

This chapter provides the programming sequences required for IEEE1284 interface setup.

Use the keys of the printer's operator panel and enter the required options. Refer to the Menu Definition Tables in this chapter for an explanation of each menu screen.

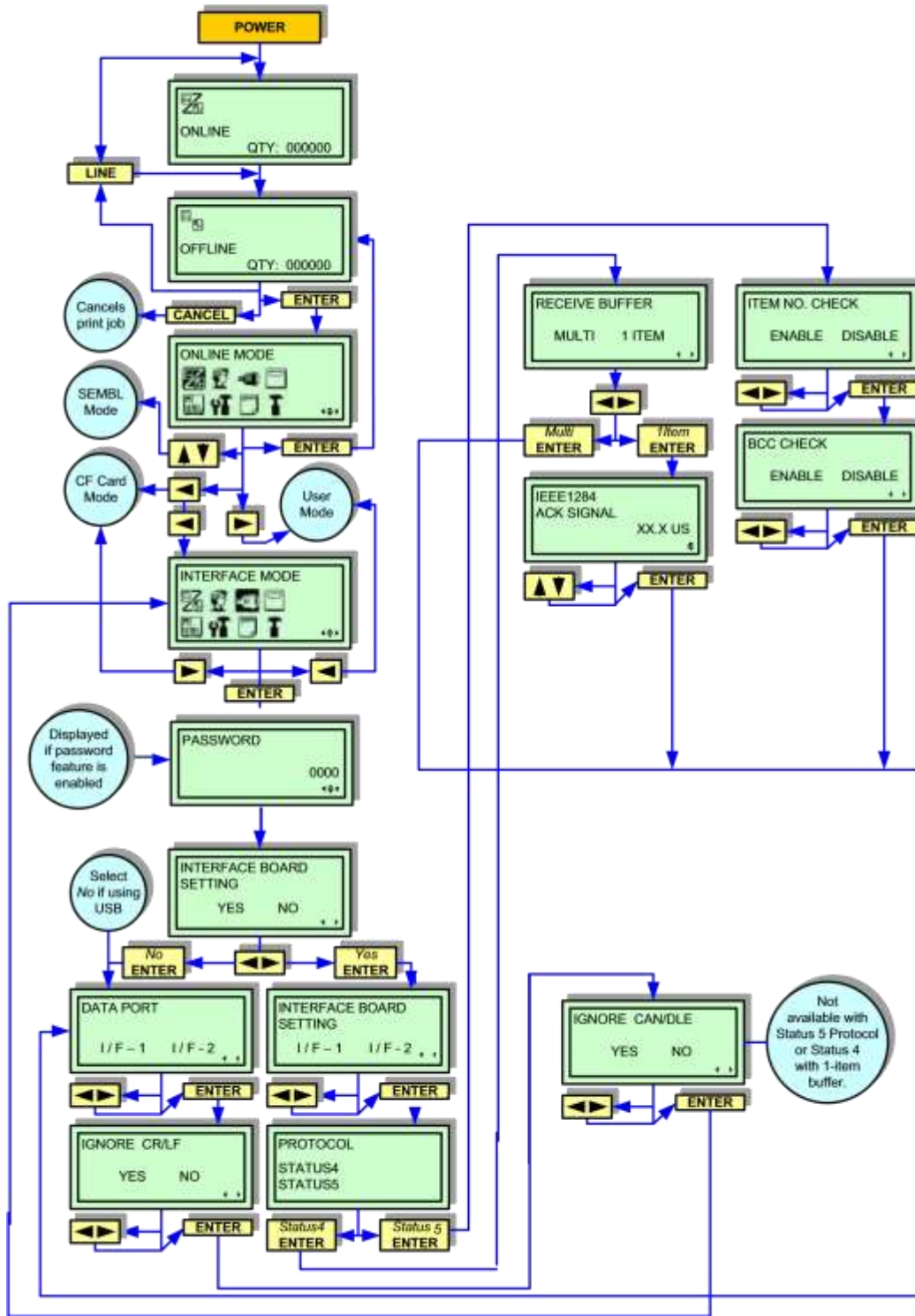

Figure 4-3, Parallel Interface Mode

SERIAL INTERFACE MODE

This chapter provides the programming sequences required for RS232, RS422, or RS485 interface setup.

Use the keys of the operator panel to select and enter the required options. Refer to the Menu Definition Tables in this chapter for an explanation of each menu screen.

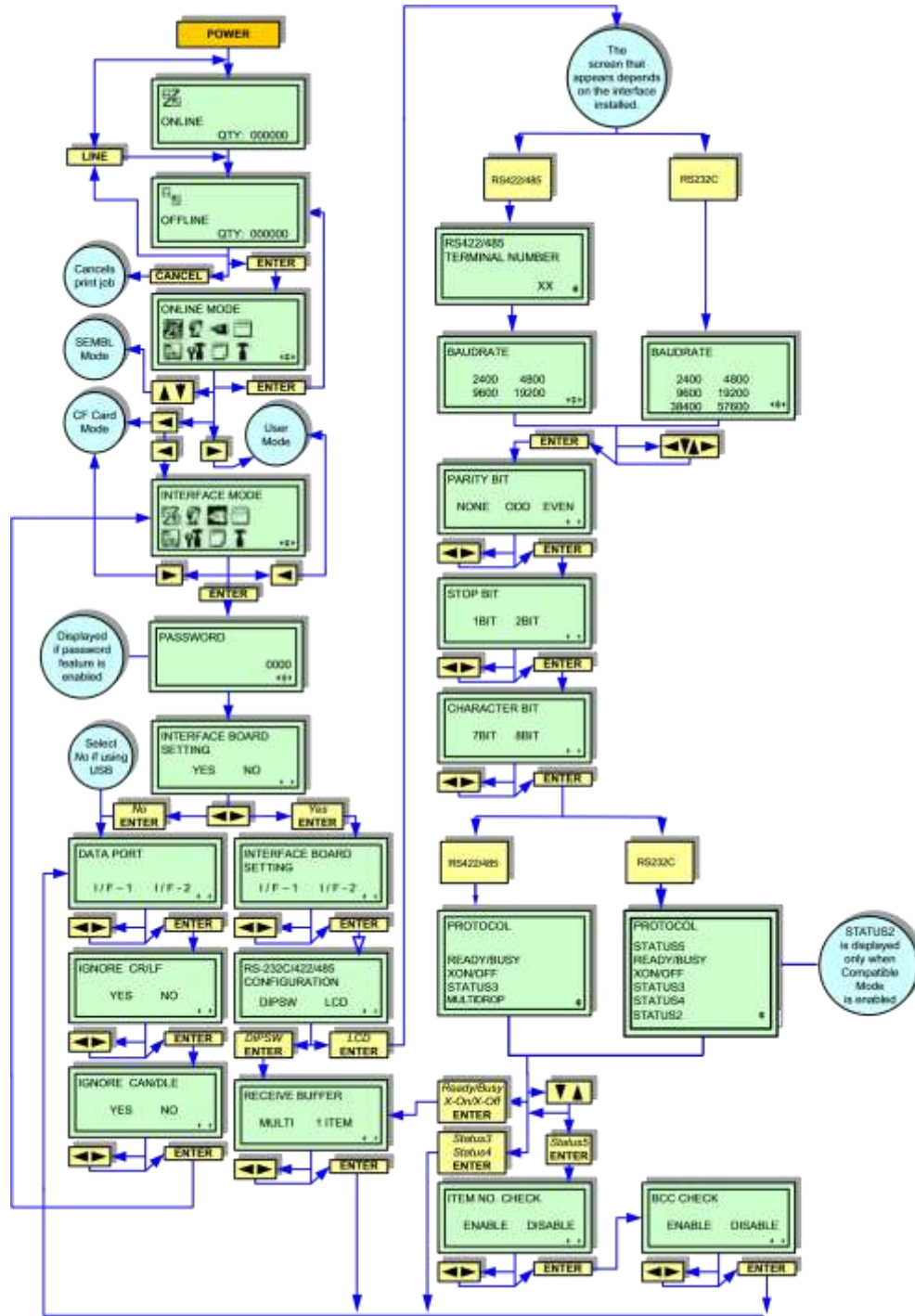

Figure 4-4, Serial Interface Mode

LOCAL AREA NETWORK (LAN) INTERFACE MODE

This chapter provides the programming sequences required for LAN setup.

Use the keys of the printer's operator panel to select and enter the required options. Refer to the Menu Definition Tables in this chapter for an explanation of each menu screen.

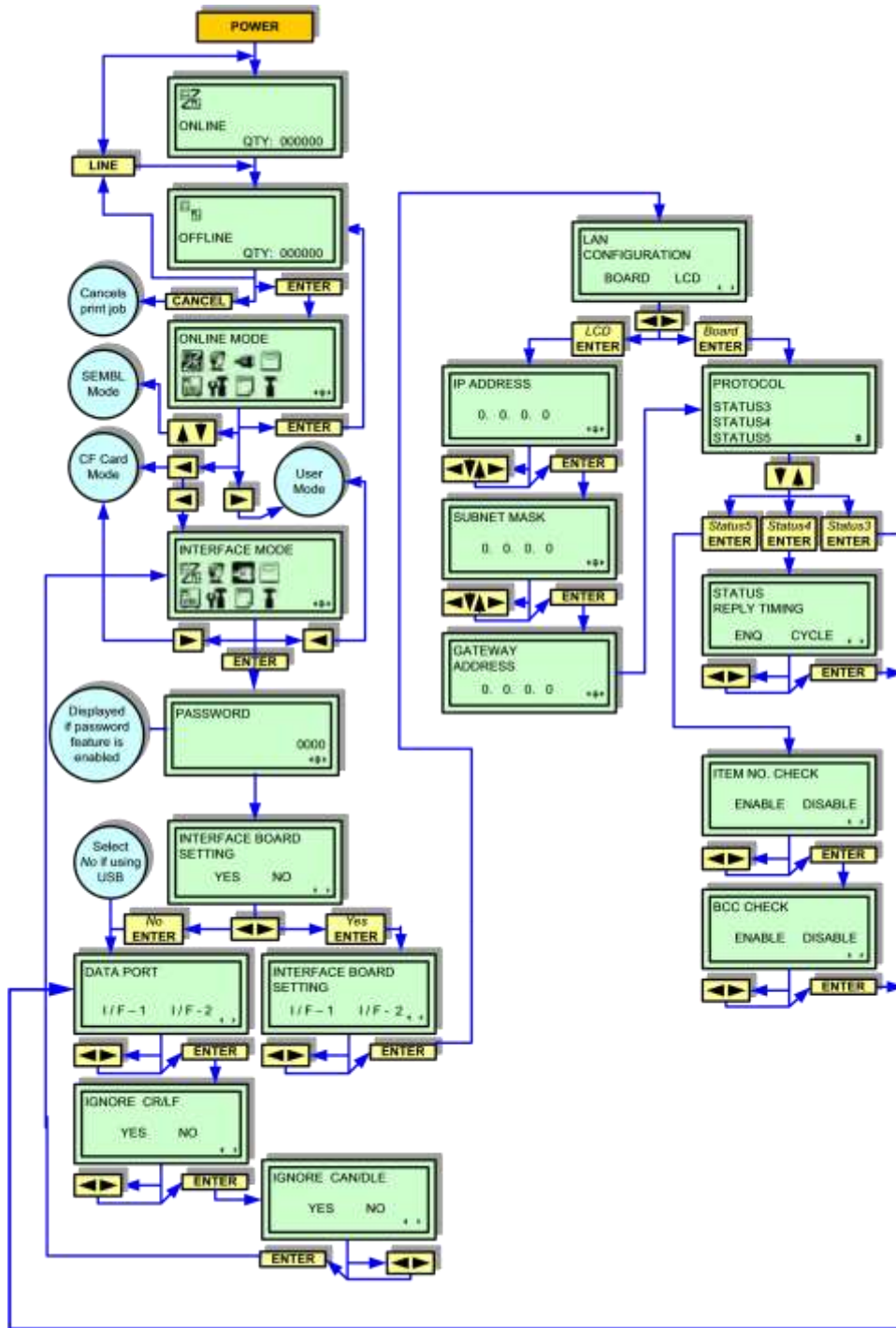

Figure 4-5, LAN Interface Mode

UNIVERSAL SERIAL BUS (USB) MODE

This chapter provides the programming sequences required for USB interface setup.

Use the keys of the printer's operator panel to select and enter the required option. Refer to the Menu Definition Tables in this chapter for an explanation of each menu screen.

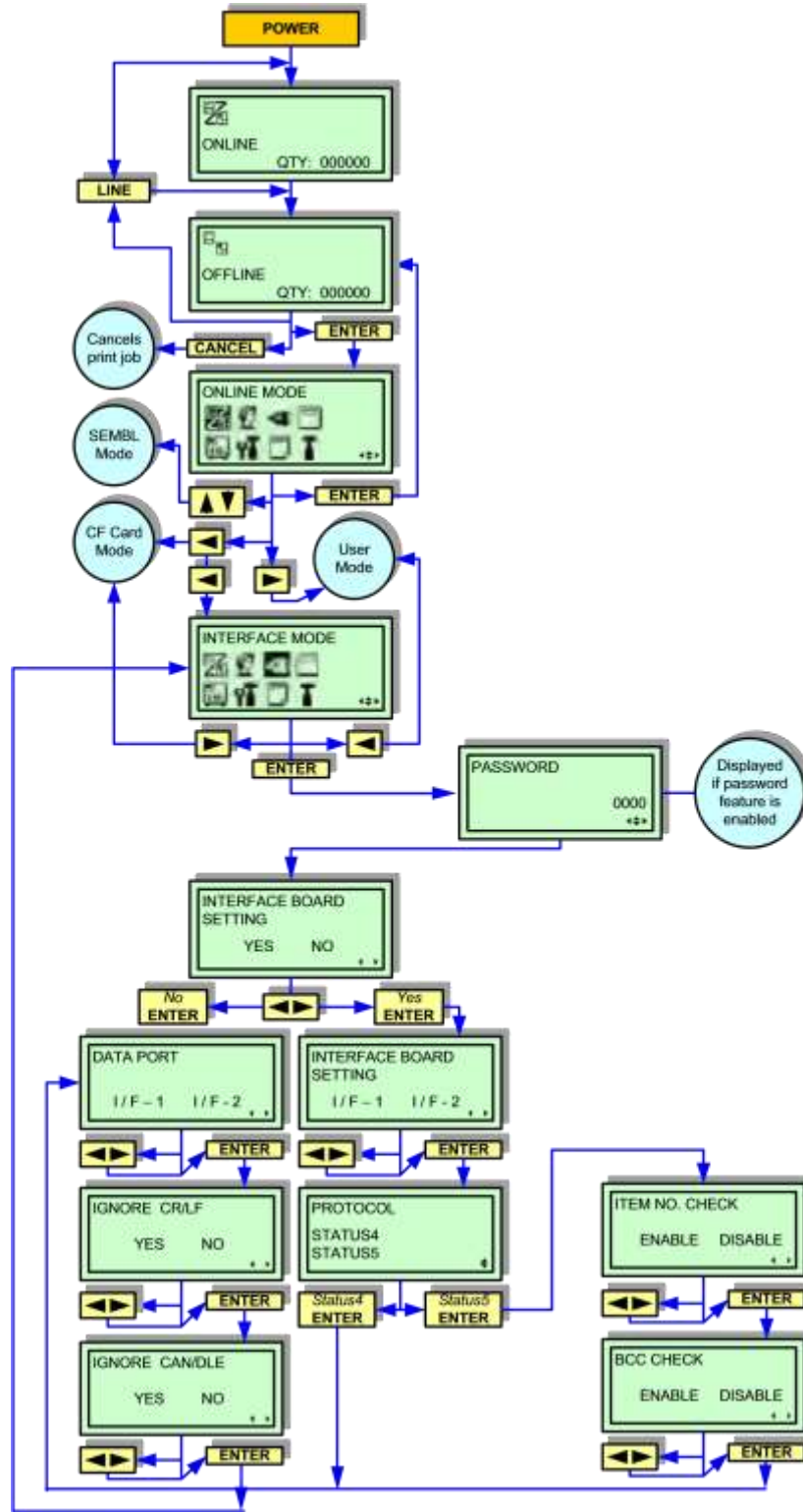

Figure 4-6, USB Interface Mode

CENTRONICS INTERFACE MODE

This chapter provides the programming sequences required for Centronics interface setup.

Use the keys of the printer's operator panel to select and enter the required options. Refer to the Menu Definition Tables in this chapter for an explanation of each menu screen.

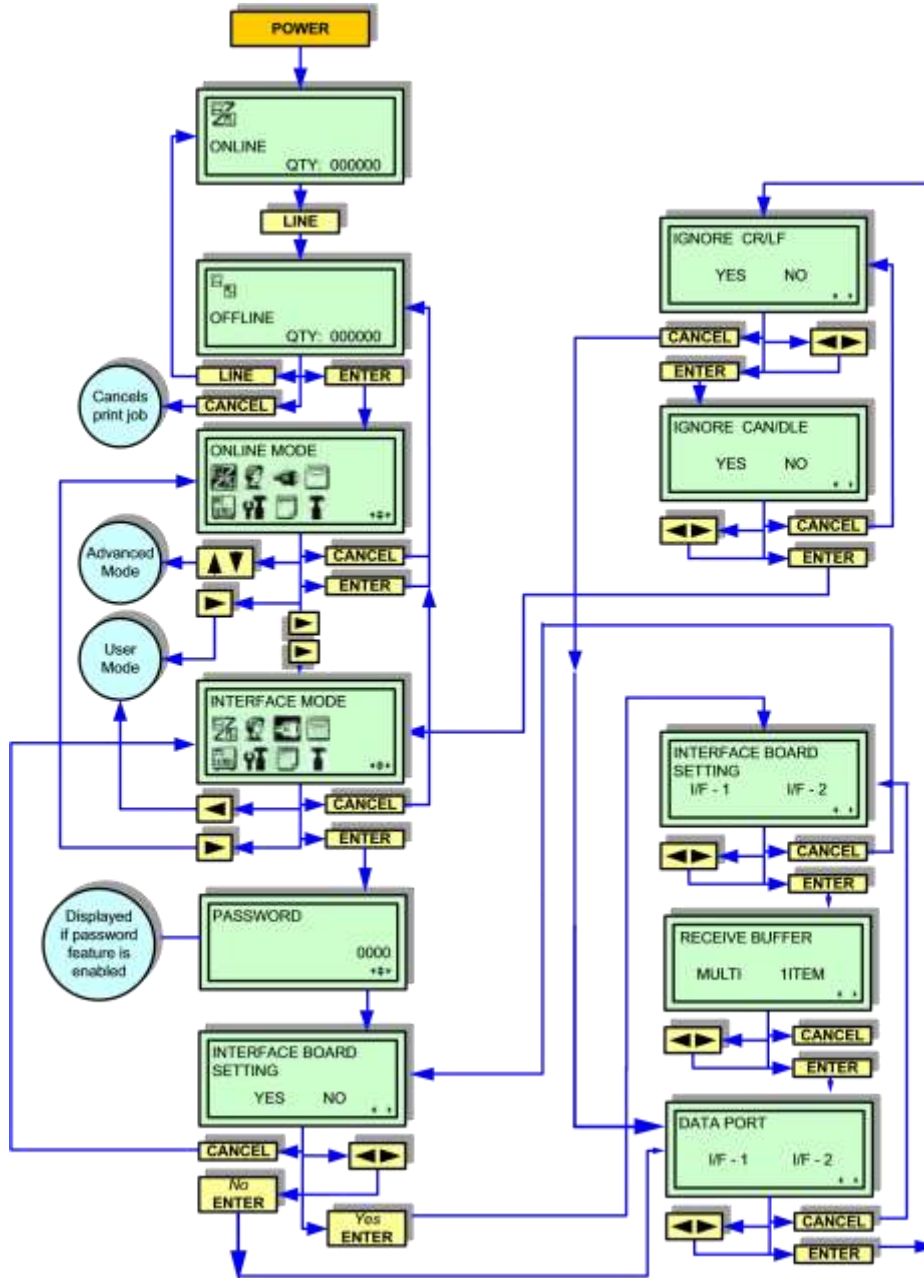

Figure 4-7, Centronics Interface Mode

WIRELESS LAN (LOCAL AREA NETWORK) INTERFACE MODE

Use the keys of the printer’s operator panel to select and enter the required options. Refer to the Menu Definition Tables in this chapter for an explanation of each menu screen.

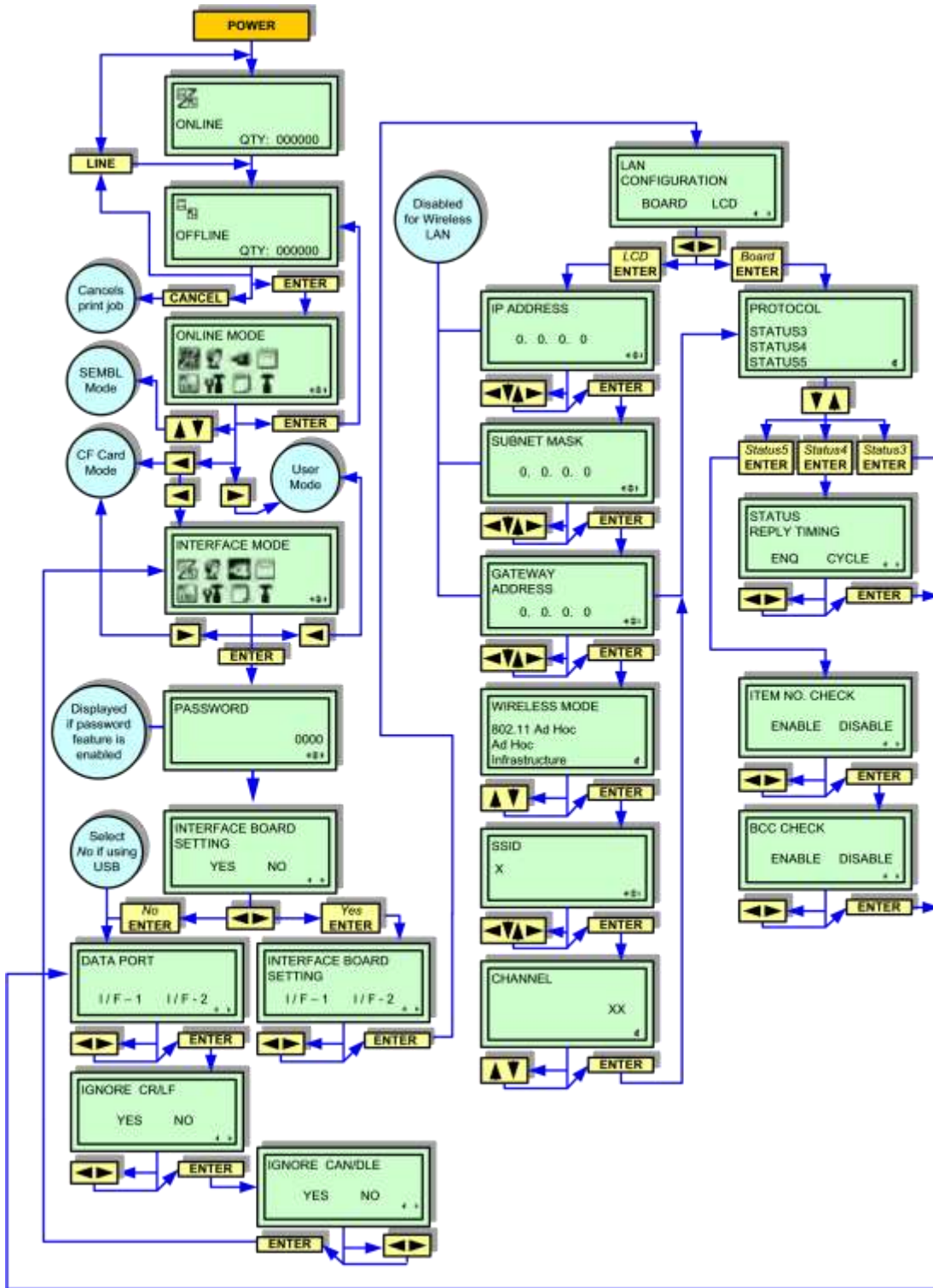

Figure 4-8, Wireless LAN Interface Mode

SERVICE MODE

Allows the programming of various dimensional settings, sensor thresholds, and language options.

Use the keys of the printer’s operator panel to select and enter the required options. Refer to the Menu Definition Tables in this chapter for an explanation of each menu screen.

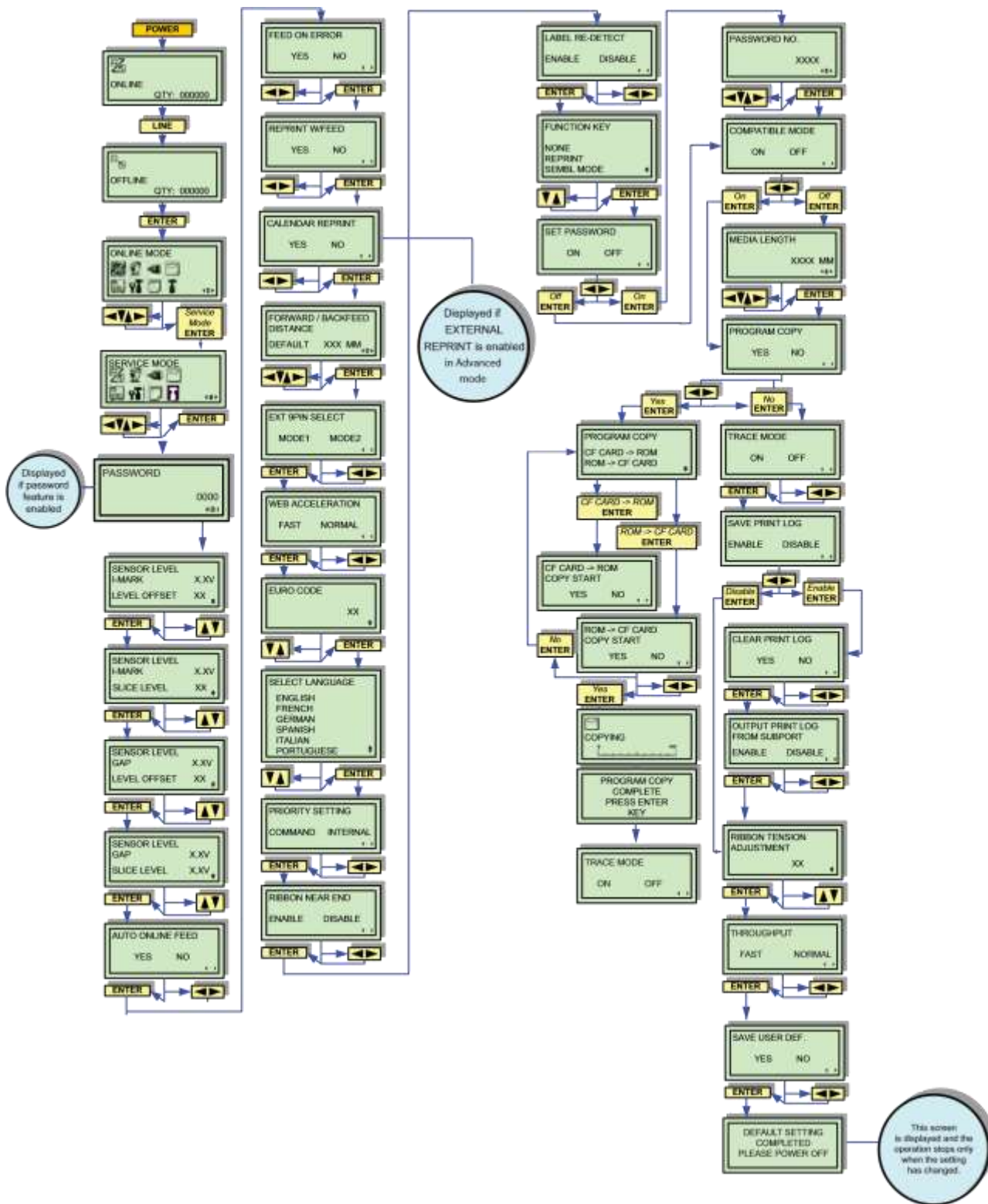

Figure 4-9, Service Mode

FACTORY MODE

The Factory Mode permits counter reset of various components.

Use the keys of the printer’s operator panel to select and enter the required options. Refer to the Menu Definition Tables in this chapter for an explanation of each menu screen.

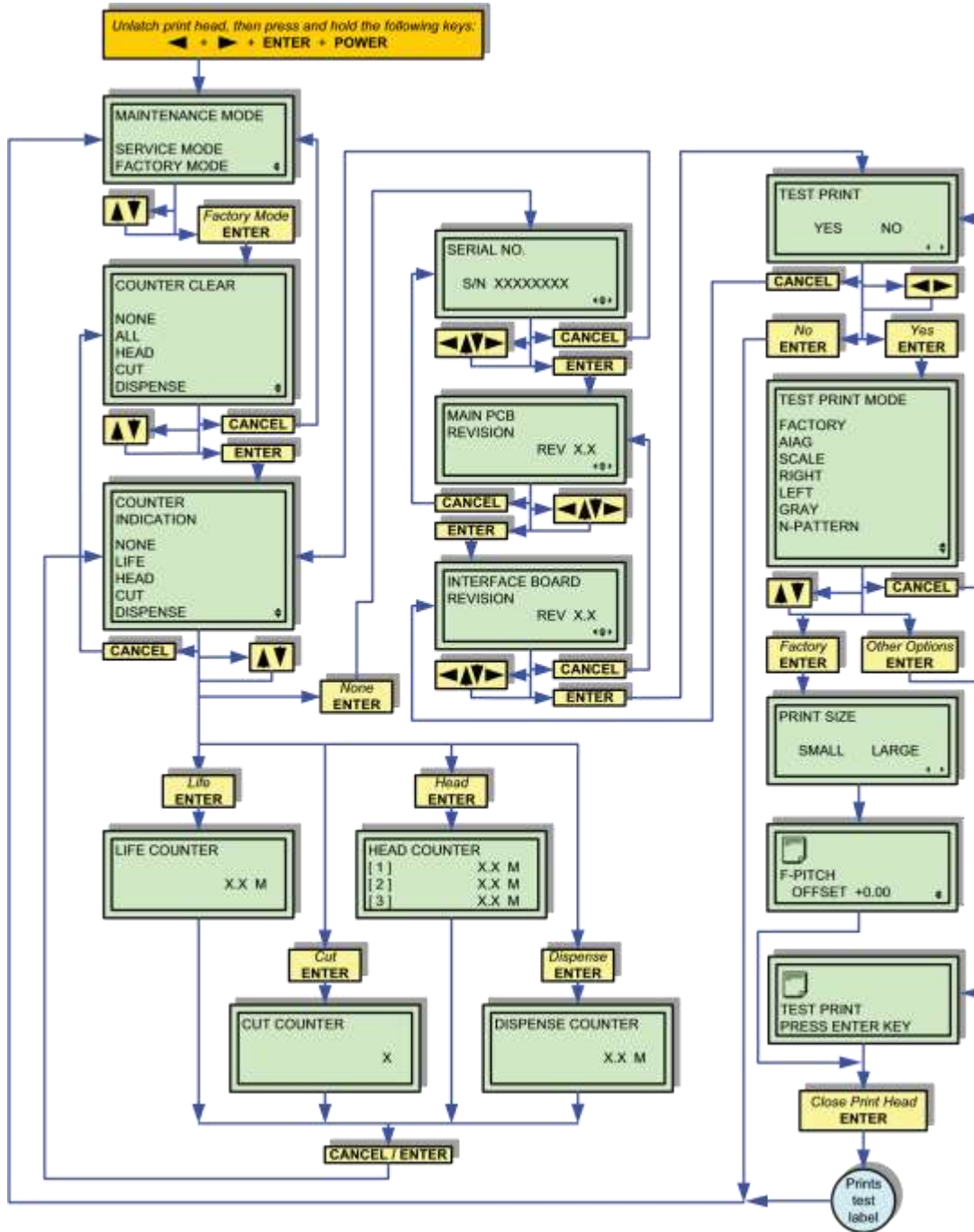

Figure 4-10, Factory Mode

FACTORY MODE WITH RFID INSTALLED

The Factory Mode with RFID Installed provides access to the RFID module settings. This menu is available only when the RFID option is installed.

Unit 4: Printer Configuration

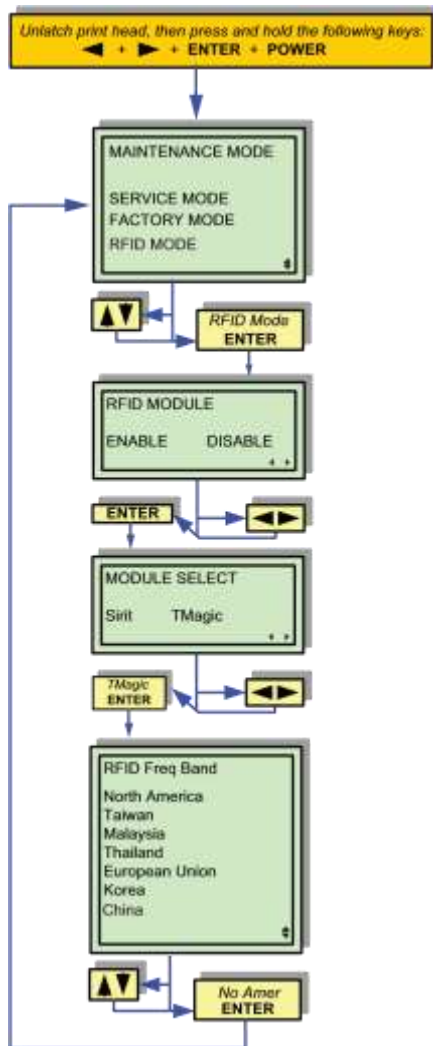

Figure 4-11, Factory Mode with RFID

RFID USER MODE

The RFID User Mode allows you to configure the RFID reading and writing features. This menu is available only when the RFID option is installed.

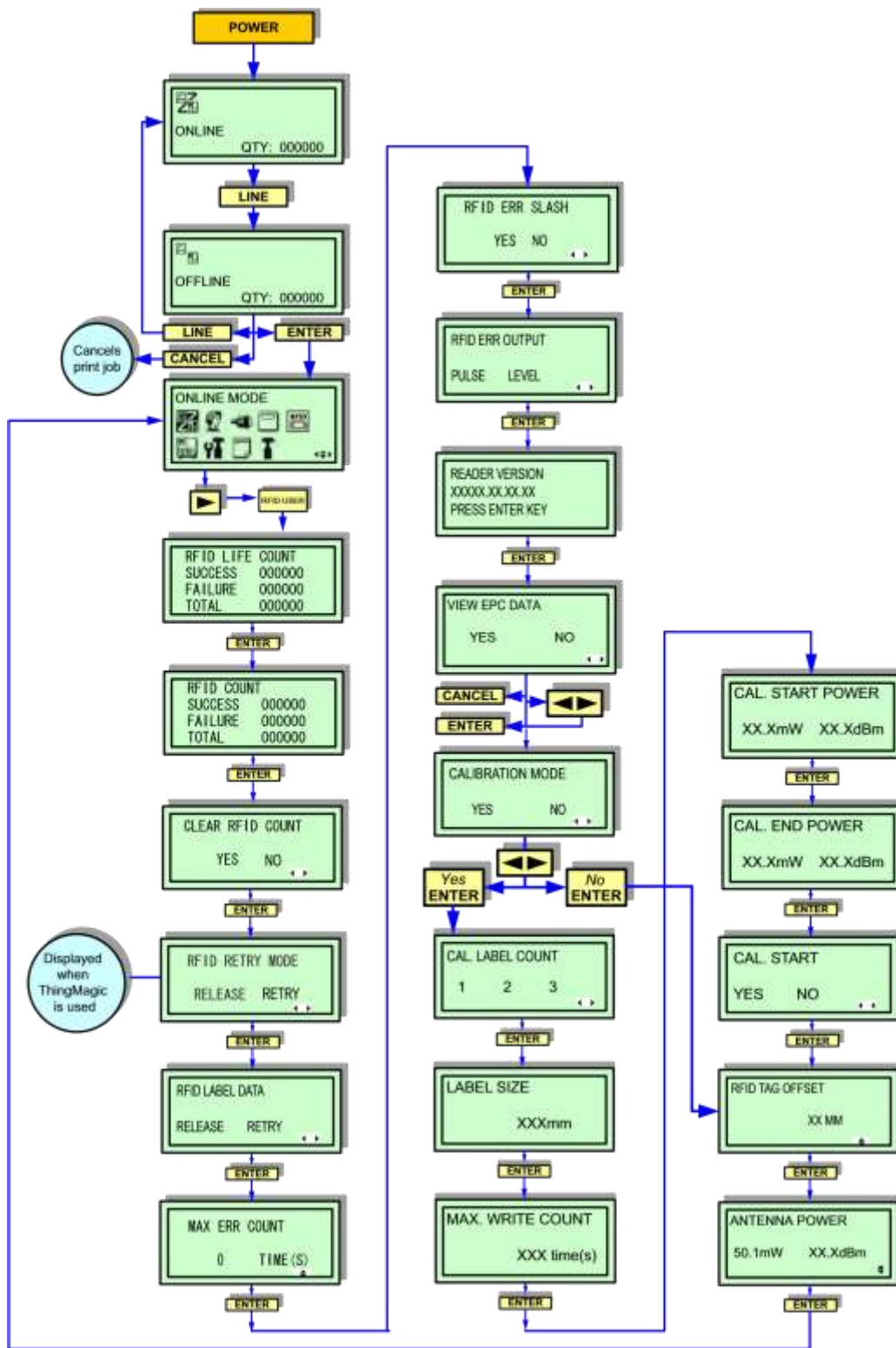

Figure 4-12, RFID User Mode

WORK SHIFT MODE

The Work Shift Mode allows for specific production shift information to be printed on a label when used with the printer SBPL command.

Use the keys of the printer’s operator panel to select and enter the required options. Refer to the Menu Definition Tables in this chapter for an explanation of each menu screen.

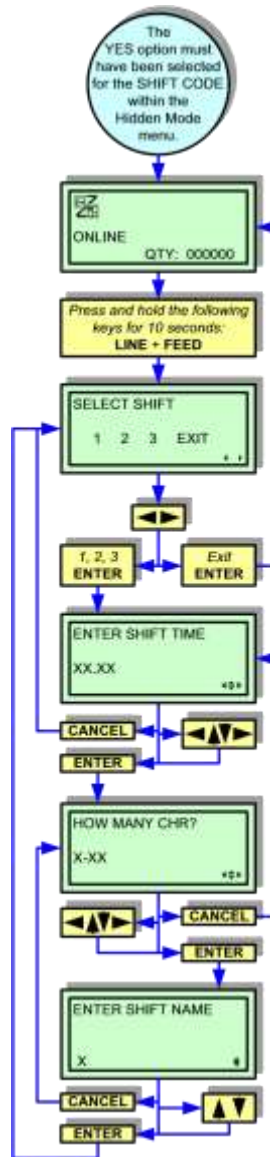

Figure 4-13, Work Shift Mode

HIDDEN MODE

The Hidden Mode allows operator access to set Label-Out Sensor status and Work Shift mode status.

Figure 4-14 provides the specific sequence of events required by the operator, the printer, and the printer’s software. Use the printer’s operator panel to select and enter the required options.

Refer to the Menu Definition Tables in this chapter for an explanation of each menu screen.

Unit 4: Printer Configuration

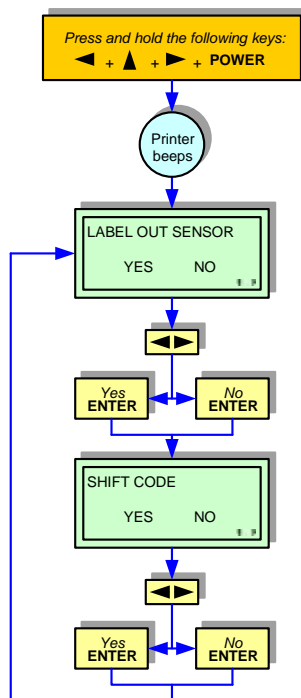

Figure 4-14, Hidden Mode

DOWNLOAD MODE

This download feature allows the operator to upgrade or downgrade firmware to the printer. When downloading is complete, the LCD screen will return to the original display. If an error occurs, a DOWNLOAD ERROR will display.

Use the printer's operator panel to select and enter the required options. Refer to the Menu Definition Tables in this chapter for an explanation of each menu screen.

Unit 4: Printer Configuration

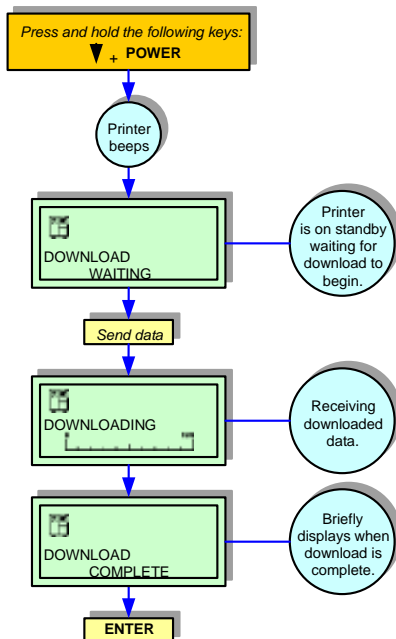

Figure 4-15, Download Mode

BOOT DOWNLOAD MODE

This download mode is used when the firmware becomes corrupted and the normal download mode is not successful.

Use the printer's keys to select and enter the required options. Refer to the Menu Definition Tables in this chapter for an explanation of each menu screen.

Unit 4: Printer Configuration

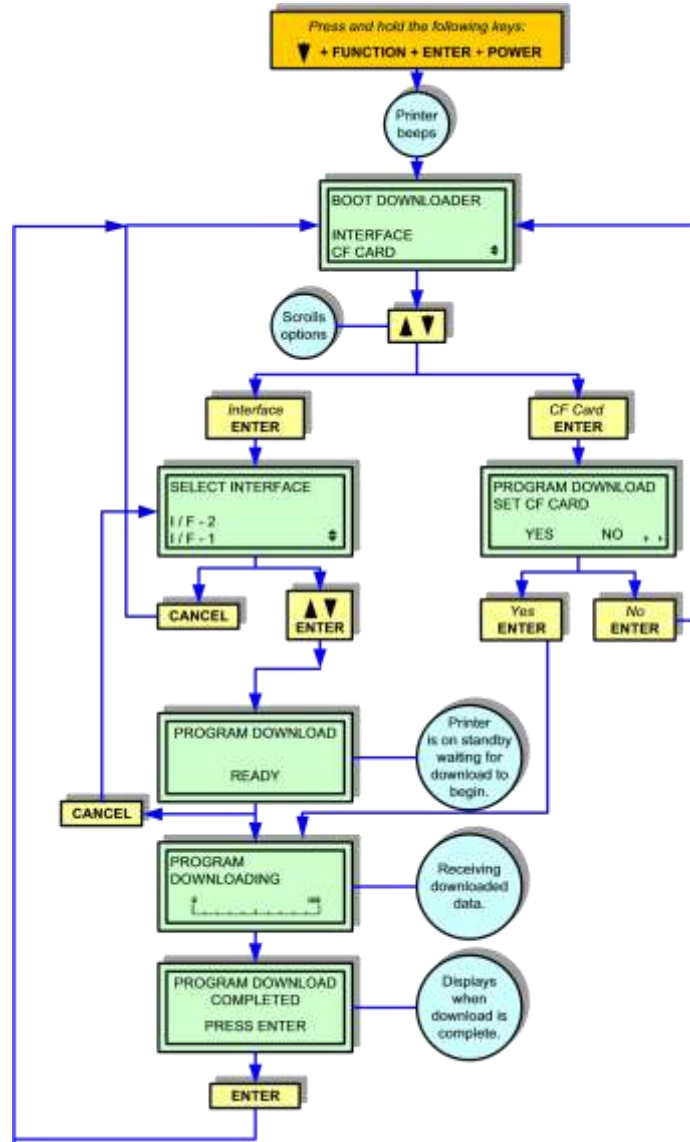

Figure 4-16, Boot Download Mode

PRINT CANCEL MODE

Figure 4-17 provides the specific sequence of events required by the operator, the printer, and the printer's software to cancel a print job once initiated.

Use the printer's operator panel to select and enter the required options. Refer to the Menu Definition Tables in this chapter for an explanation of each menu screen.

Unit 4: Printer Configuration

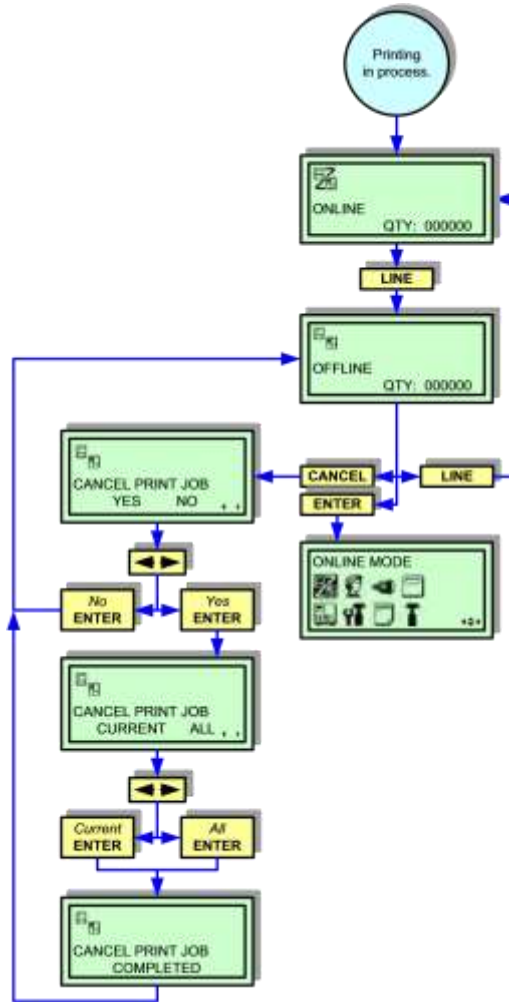

Figure 4-17, Print Cancel Mode

DEFAULT SETTINGS MODE

Figure 4-18 provides the specific sequence of events required by the operator, the printer, and the printer's software to return the printer to the configuration as received from the factory.

Use the printer's operator panel to select and enter the required options. Refer to the Menu Definition Tables in this chapter for an explanation of each menu screen.

Unit 4: Printer Configuration

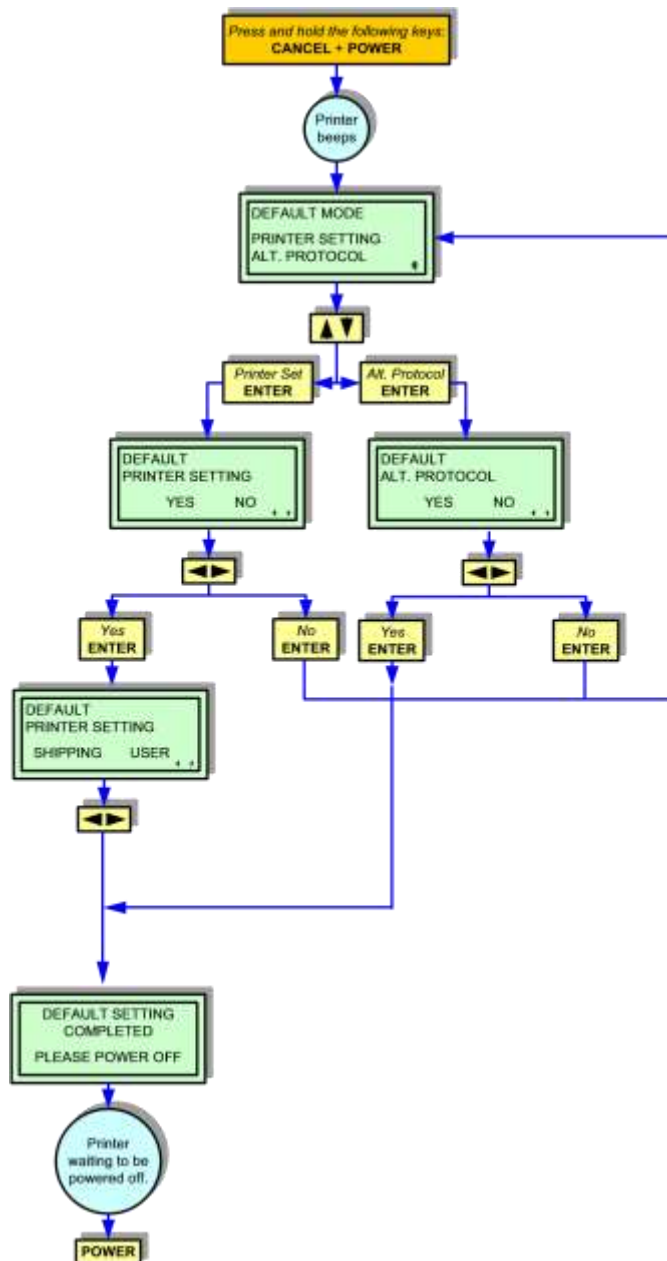

Figure 4-18, Default Settings Mode

TEST PRINT MODE

Figure 4-19 provides the specific sequence of events required by the operator, the printer, and the printer's software for a test label to be printed. Test labels are designed to identify failures in configuration, adjustment problems, and mechanical defects.

Use the keys on the printer's operator panel to select and enter the required options. Refer to the Menu Definition Tables in this chapter for an explanation of each menu screen.

Unit 4: Printer Configuration

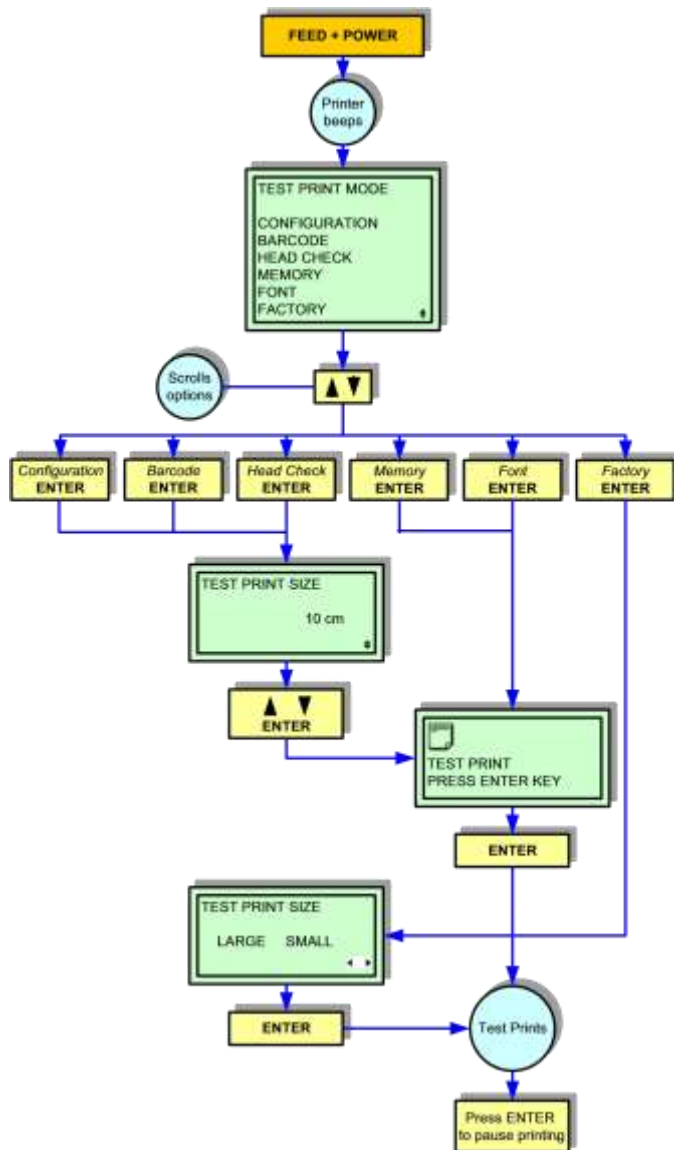

Figure 4-19, Test Print Mode

HEX DUMP MODE

The contents of the print buffer and the data received before it is placed into the print buffer may be examined through the use of the Hex Dump Mode. Each line of the printed data is enumerated in the first column, the second column contains the data in hexadecimal format, and the right column contains the same data in ASCII format.

The options are: receive data, receive buffer, internal data, and send back data. However, only one type of data may be printed on a single label. Repeat the hex dump process to print the other data types as desired. You cannot enter the Hex Dump Mode when a print item exists.

The following four types of data are available for Hex Dump printing.

- Data received after setting Hex Dump Mode.
- Data (for one item) received before setting Hex Dump Mode.
- Data registered in internal buffer.
- Returning received data, which is a single item.

Use the buttons on the printer's operator panel to select and enter the required options. Refer to the Menu Definition Tables in this chapter for an explanation of each menu screen.

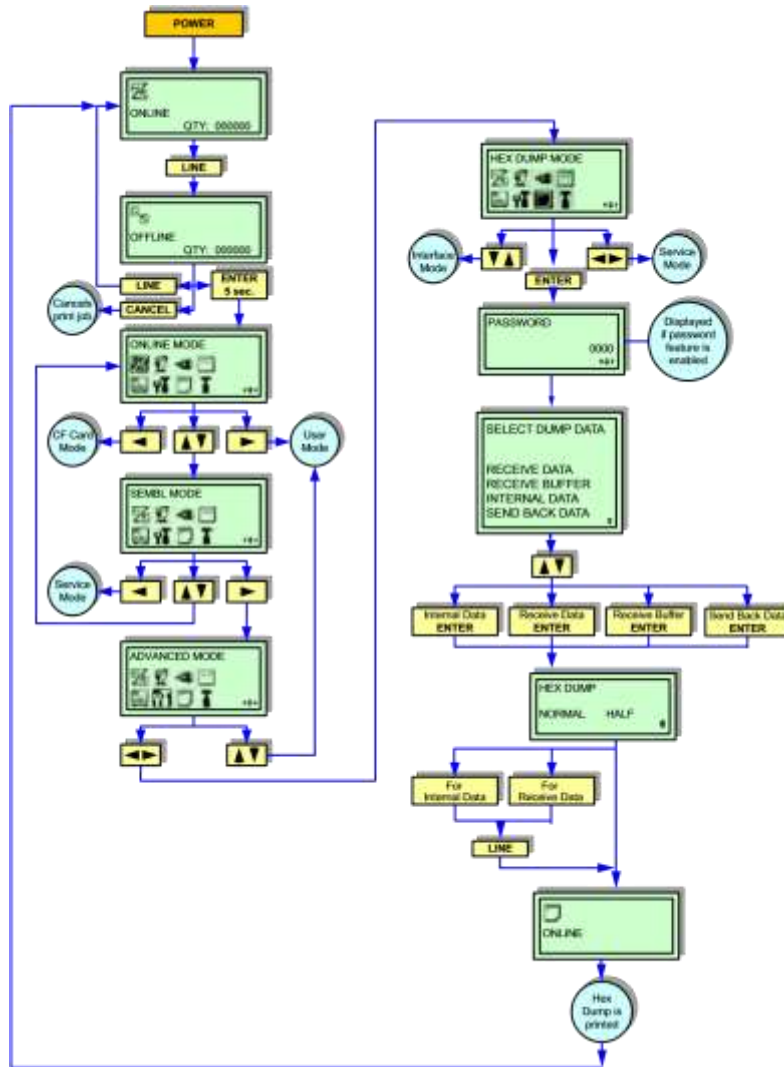

Figure 4-20, Hex Dump Mode

CF (COMPACT FLASH) CARD MODE

Use the printer's operator panel to select and enter the required options. Refer to the Menu Definition Tables in this chapter to provide an explanation of each screen.

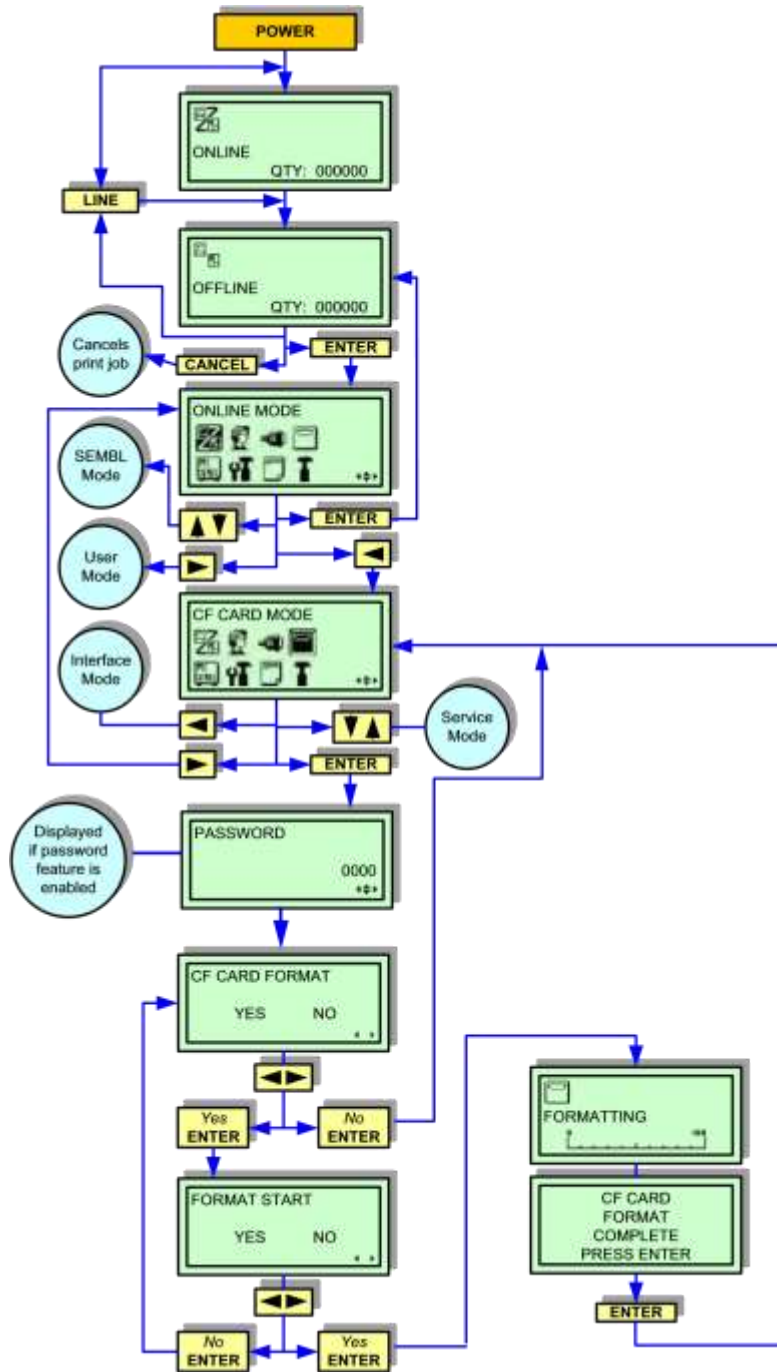

Figure 4-21, CF Card Mode

STAND ALONE MODE

The Stand Alone Mode allows the printer to function independently from a host computer once a fixed format has been sent, and saved, to the flash-memory card.

The data may be saved to the flash-memory card while in the print buffer, and then recalled later with a new print quantity indicated. The flash-memory card will only hold a single format at a time; new formats will overwrite the existing saved format. The host computer must be reconnected to the printer to overwrite an existing format.

Unit 4: Printer Configuration

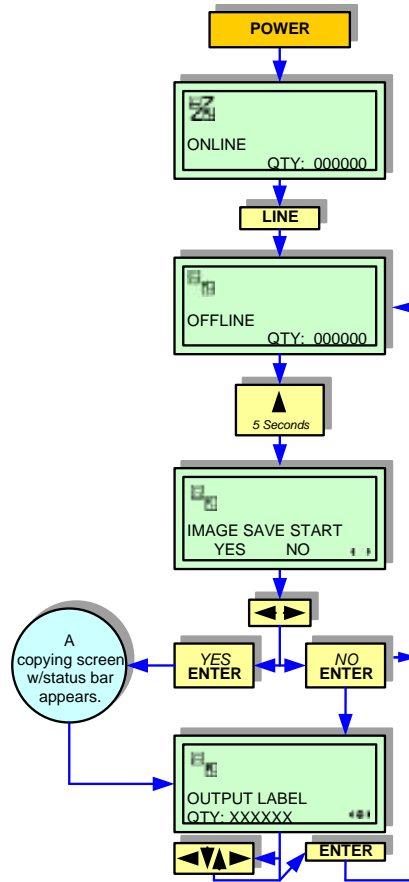

Figure 4-22, Stand Alone Mode

SATO + SZPL EMULATION MODE

The SZPL Emulation Mode is available when the printer is configured with SZPL Emulation firmware. The RFID option is not supported in this emulation firmware.

Unit 4: Printer Configuration

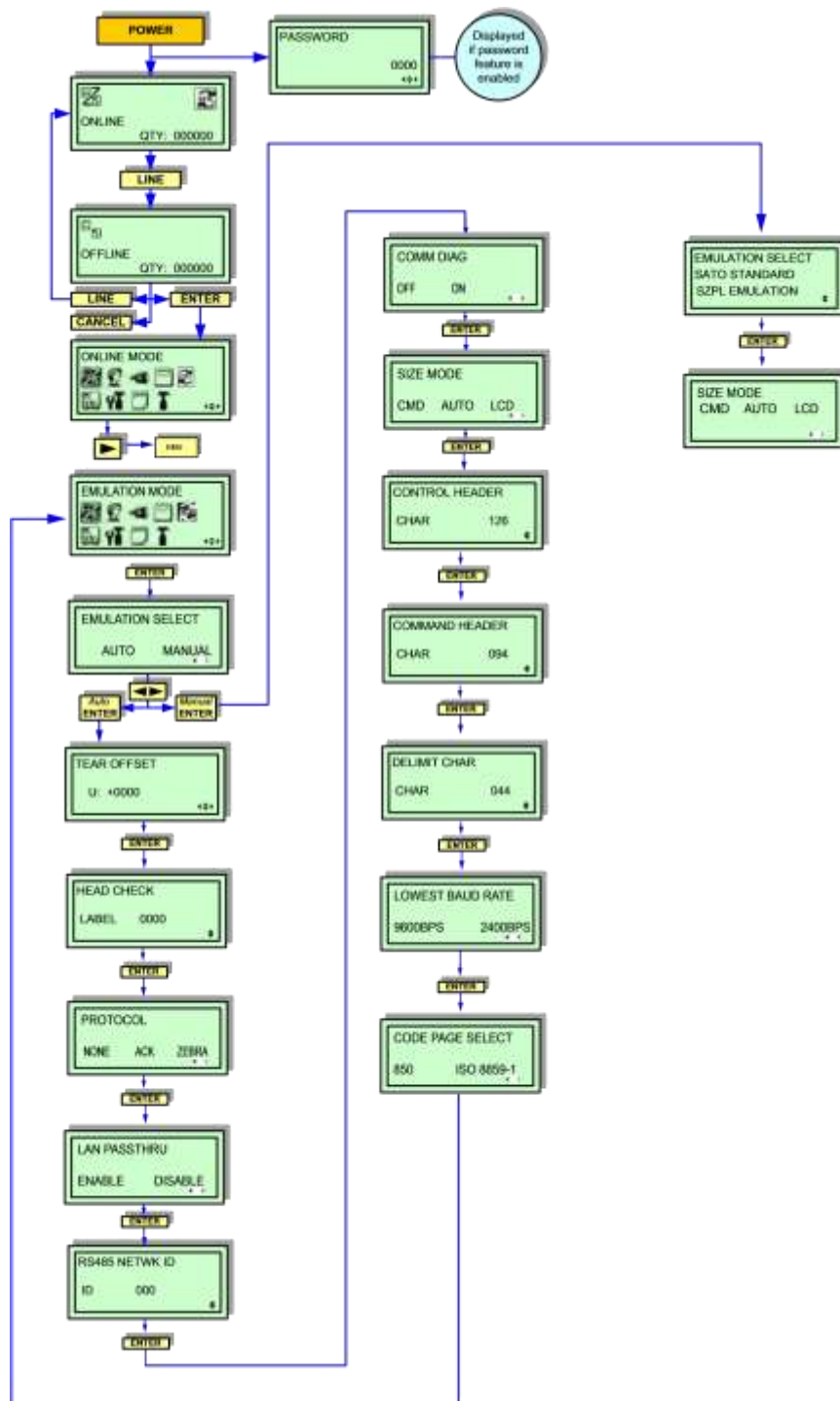

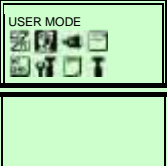
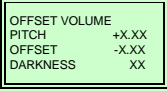
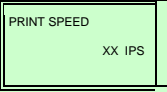
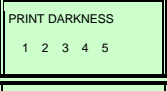
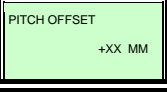

Figure 4-23, SZPL Emulation Mode

MENU DEFINITION TABLES

USER MODE (TABLE 4-1)

MENU	DESCRIPTION
	Is the entrance screen to the User Mode. The User Mode allows various print parameters to be

Unit 4: Printer Configuration

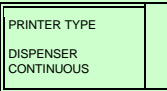
	<p>set.</p>
	<p>This screen shows the adjusted value for the potentiometers on the Operator Panel. Entry is not required for this screen. The values will change as the potentiometers are adjusted.</p>
	<p>Permits the printer's print speed to be established based on inches per second (IPS).</p>
	<p>Permits the adjustment of the print density. Higher print density equates to darker print images.</p>
	<p>The label pitch is the distance from the leading edge (the edge that comes out of the printer first) of a label and the leading edge of the next label. The position of the label's leading edge can be adjusted relative to the print head in increments of 1mm. Once the position has been set, it can be fine adjusted using the PITCH potentiometer.</p> <p>Positive (+) digit selection on the display moves the leading edge forward and away from the print head while a negative (-) selection moves the label's leading edge incrementally back into the mechanism.</p>
<p>ADVANCED MODE (TABLE 4-2)</p>	
<p align="center">MENU</p>	<p align="center">DESCRIPTION</p>
	<p>Is the first menu screen of the Advanced Mode. The Advanced Mode is provided to make advanced printer operational adjustments. Typically, once these adjustments or settings have been made, they will not require additional address unless the application significantly changes.</p>
	<p>This menu sets the darkness range used by PRINT DARKNESS screen in the User Mode. Darkness range A is the default. Darkness range B offers higher temperatures across the print darkness range and may be necessary when using high resin content ribbons.</p>
	<p>Allows choice of continuous feed or dispenser operation.</p>

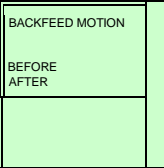

Unit 4: Printer Configuration

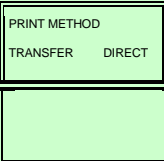
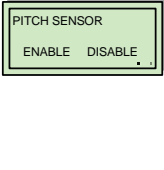
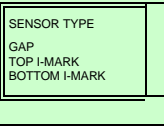
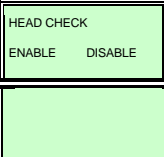
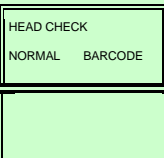
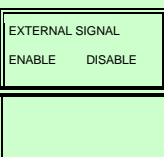
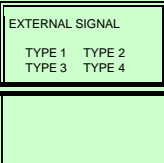
	<p>Allows the determination of whether a backfeed motion will be applied. If so, the selection of before or after the printing of each label.</p>
---	---

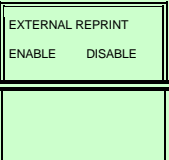
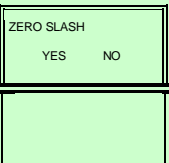
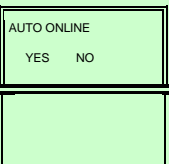

ADVANCED MODE (TABLE 4-2)	
MENU	DESCRIPTION
	<p>Allows the printer to be switched to operate in the thermal transfer or direct thermal mode as desired.</p>
	<p>Allows the pitch sensor to be enabled or disabled.</p>
	<p>Allows the pitch sensor mode to be selected relative to the media type being used.</p>
	<p>This feature determines the intensity of the print head elements when enabled. The printer will go into error mode when a malfunctioning print head element is detected.</p>
	<p>This screen will appear if the print head check feature has been enabled. Choose for the head check to be performed unconditionally or only when barcodes are being printed. Previously printed barcodes should be scanned following an error to determine their functionality.</p>
	<p>Set this feature to enable or disable an external signal for other printer's communication port. If the port is enabled, an external print start signal can be sent and received using an appropriate device plugged into the EXT port.</p>
	<p>Appears only if the printer's external signal feature has been enabled to allow selection of the output signal. For information on which type to choose, refer to the printer's Programming Reference for guidance.</p>

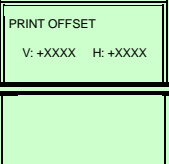
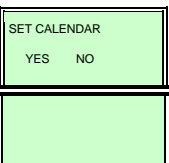
Unit 4: Printer Configuration

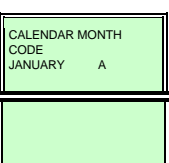
	<p>Allows configuration as to whether the reprint function may be activated via the external signal port.</p>
	<p>This menu allows for the printer to be configured to print zeros with or without a diagonal slash through them. This will apply to all printer font types.</p>
	<p>The printer can be set to go into the online mode when powered on. Otherwise, the printer starts in the offline state and must be manually placed online before it is ready to print.</p>

ADVANCED MODE (TABLE 4-2)	
MENU	DESCRIPTION
	<p>Print offset refers to the vertical and horizontal shifting of the entire print area relative to the label and the print start position. The movement is incremental by dots in the positive (+) or negative (-) direction. Positive and negative vertical adjustment is toward or away from the print head respectively. Positive and negative horizontal adjustment is to the left or right of the reference point respectively.</p>
	<p>The calendar is a feature that allows the date and time to be manually set using the operator panel or through command codes.</p> <p>This screen prompts to indicate whether calendar setting is desired or not. If YES is selected, the calendar setup screen will appear. If NO is selected, the menu will advance and bypass the calendar setup option.</p>
	<p>This menu screen allows the calendar settings to be altered. The calendar is divided into five sets of two digits. The first two allows for the year to be set, followed by the month, the day, the hour, then the minute.</p>
	<p>This menu allows you to set the Single Character Calendar Month Code.</p> <p>The selection range is A-Z, a-z. The default value is: A-JAN, B-FEB, C-MAR, D-APR, E-MAY, F-JUN, G-JUL, H-AUG, J-SEP, K-OCT, L-NOV and M-DEC.</p> <p>←, → : Select one character month code. ↓, ↑ : Backup or Advance to next month. ENTER: Accept settings and advance to next menu. CANCEL: Disregard setting and revert back to previous menu.</p>

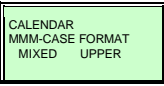
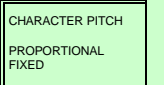
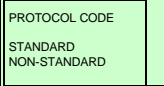
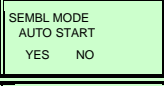
Unit 4: Printer Configuration

	<p>This menu screen allows the setting of the Calendar MMM Month Code Case Format. MIXED or UPPER. The default value is MIXED.</p> <p>←, → : Select MIXED or UPPER.</p> <p>ENTER: Accept settings and advance to next menu.</p> <p>CANCEL: Disregard setting and revert back to previous menu.</p>
	<p>Determines whether each printer character occupies a designated space (fixed) regardless of the characters width, or if the character's space is representative of its width (proportional). This will apply to all printer resident font types.</p>
	<p>The ESC sequence in SBPL (SATO Basic Programming Language) commands may be defined as standard (using non-printable code 1BH) or non-standard (some other user code).</p>
	<p>Allows the determination of whether the printer will automatically enter the SEMBL Mode upon powering on the printer.</p>
	<p>Allows for selection of specific SEMBL program to be started when SEMBL mode AUTO START selection is YES.</p>

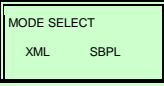
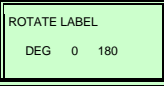
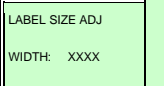
ADVANCED MODE (TABLE 4-2)	
MENU	DESCRIPTION
	<p>This menu screen allows the setting of the printer in either SBPL mode or XML mode.</p>
	<p>This menu screen allows the printing of label either in a programmed orientation or rotated 180 degrees from the programmed orientation.</p>
	<p>This menu screen allows the setting of label width in dots. This is used in conjunction with Rotate Label setting and SZPL mode.</p> <p>The setting range and default value varies depending on the print density of the printer.</p> <p>(8 dot/mm) Default value: 832 Setting range:0000~0832</p> <p>(12 dot/mm) Default value: 1248 Setting range:0000~1248</p> <p>(24 dot/mm) Default value: 2496 Setting range:0000~2496</p>

Unit 4: Printer Configuration

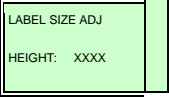
	<p>This menu screen allows the setting of label length in dots. This is used in conjunction with Rotate Label setting and SZPL mode.</p> <p>The setting range and default value varies depending on the print density of the printer.</p> <p>(8 dot/mm) Default value: 20000 Setting range: 0000~20000 (12 dot/mm) Default value: 18000 Setting range: 0000~18000 (24 dot/mm) Default value: 9600 Setting range: 0000~9600</p>
---	--

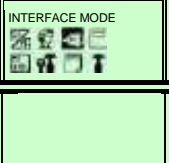
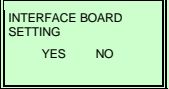
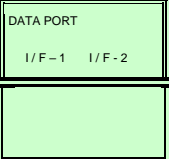
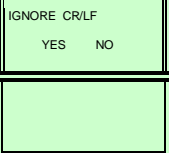
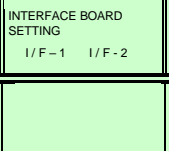

PARALLEL INTERFACE MODE (TABLE 4-3)

MENU	DESCRIPTION
	<p>Is the premiere screen of the Interface Mode. The Interface Mode allows the parameters to be set for the printer to communicate with a host and vice-versa.</p>
	<p>Select the YES option to configure an interface board for bi-directional communication, the menu will advance to multiple configuration screens depending on the type of interface board installed.</p> <p>Selecting the NO option will bypass those screens.</p>
	<p>Allows the selection of which interface port will be assigned to receive print data. Interface Port 1 (I/F-1) is not in use. Interface Port 2 (I/F-2) is the printer's middle card slot. The default setting is I/F-2 and accommodates a standard interface card.</p>
	<p>Determines whether the print data code requires deletion. Hexadecimal graphic data will not be deleted. Select YES to delete all Carriage Returns (CR) and Line Feed (LF) commands in the data stream - including graphics and 2D bar codes. Select the NO option to process them.</p> <p>This feature is primarily used to maintain compatibility with earlier models of SATO printers.</p>
	<p>Allows the selection of which interface board will be set up in subsequent menus. Interface Port 2 (I/F-2) is the printer's middle card slot. The default setting is I/F-2 and accommodates a standard interface card. I/F-1 is not in use.</p>

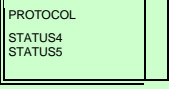
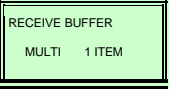
PARALLEL INTERFACE MODE (TABLE 4-3)

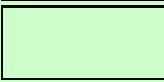
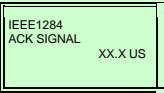
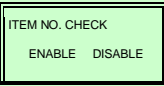
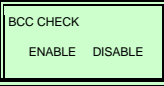
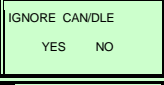

MENU	DESCRIPTION
	<p>Allows setting of bi-directional communication protocol.</p>
	<p>Allows the selection of the receive buffer type. Select MULTI for multiple-item buffer and 1ITEM for a single item buffer.</p>

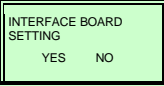
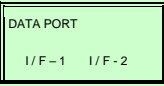
Unit 4: Printer Configuration

	
	<p>Allows setting for ACK width of the IEEE1284 interface. The display will appear when the interface is present and one item (1ITEM) is selected as a receive buffer.</p>
	<p>Allows item number check to be enabled or disabled. Will only appear when STATUS5 is set for the protocol.</p>
	<p>Allows BCC Check for ACK width of the IEEE1284 interface. The display will only appear when STATUS5 is set for the protocol.</p>
	<p>Allows the determination of whether the Cancel (CAN) and Data Link Escape (DLE) codes will be processed or ignored. Select the YES option to ignore the codes and NO to process them. This screen will only appear when the communication protocol is STATUS4.</p>
SERIAL INTERFACE MODE (TABLE 4-4)	
MENU	DESCRIPTION
	<p>Is the premiere screen of the Interface Mode. The Interface Mode allows the parameters to be set for the printer to communicate with a host and vice-versa.</p>
	<p>Select the YES option to configure an interface board for bi-directional communication, the menu will advance to multiple configuration screens depending on the type of interface board installed. Selecting the NO option will bypass those screens.</p>
	<p>Allows the selection of which interface port will be assigned to receive print data. Interface Port 1 (I/F-1) is not in use. Interface Port 2 (I/F-2) is the printer's middle card slot. The default setting is I/F-2 and accommodates a standard interface card.</p>

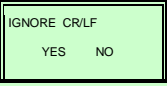
Unit 4: Printer Configuration

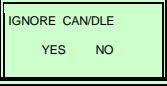
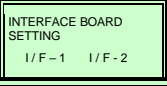
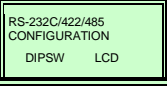
	<p>Determines whether the print data code requires deletion. Hexadecimal graphic data will not be deleted. Select YES to delete all Carriage Returns (CR) and Line Feed (LF) commands in the data stream - including graphics and 2D bar codes. Select the NO option to process them.</p> <p>This feature is primarily used to maintain compatibility with earlier models of SATO printers.</p>
---	---

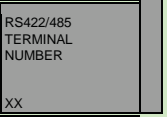
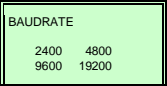
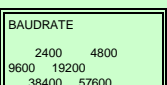
SERIAL INTERFACE MODE (TABLE 4-4)	
MENU	DESCRIPTION
	<p>Allows the determination of whether the Cancel (CAN) and Data Link Escape (DLE) codes will be processed or ignored. Select the YES option to ignore the codes and NO to process them.</p> <p>This screen will only appear when the communication protocol is STATUS4.</p>
	<p>Allows the selection of which interface board will be set up in subsequent menus. Interface Port 2 (I/F-2) is the printer's middle card slot. The default setting is I/F-2 and accommodates a standard interface card. I/F-1 is not in use.</p>
	<p>Selection of the DIPSW option will use settings on the serial interface card. The LCD option advances the operator to menus that allow the DIPSW settings to be over-written.</p>
	<p>Allows the selection of the receive buffer type. Select MULTI for multiple-item buffer and 1ITEM for a single item buffer.</p> <p>This screen will only appear if one of the serial interface types is installed and the protocol is set to READY/BUSY or XON/XOFF.</p>
	<p>Allows for the setting of the Terminal Number of the printer from 01-32.</p>
	<p>Allows selection of the baud rate. Will only appear when the RS422 or RS485 interface is installed and the LCD option is chosen from the prior menu.</p>
	<p>Allows selection of the baud rate. Will only appear when the RS232C interface is installed and the LCD option is chosen from the prior menu.</p>

Unit 4: Printer Configuration

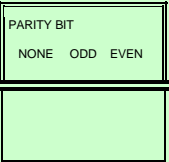
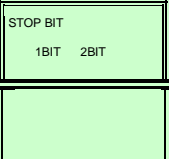
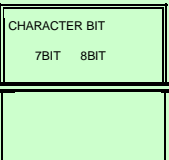
	<p>Allows setting of the parity bit for the serial interface. Will not display if the DIP switch priority option is chosen. The interface board must be installed.</p>
	<p>Allows stop bit selection for the serial interface. Will not display if the DIP switch priority is chosen.</p>
	<p>Allows selection of the data length for serial interface. Will not display if the DIP switch priority option is chosen.</p>

SERIAL INTERFACE MODE (TABLE 4-4)

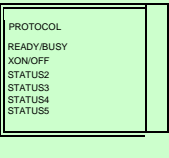
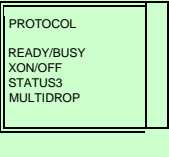
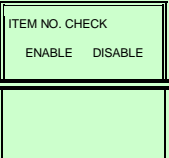
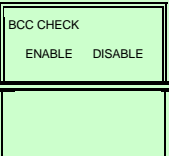
MENU	DESCRIPTION
	<p>Allows setting of communication protocol for RS232C interface. Will not display if the DIP switch priority option is chosen.</p>
	<p>Allows setting of communication protocol for RS232C interface. Will not display if the DIP switch priority option is chosen.</p>
	<p>Allows the item number check to be enabled or disabled. Will only appear when STATUS5 is set for the protocol.</p>
	<p>Allows BCC check to be enabled or disabled. Will only appear if STATUS5 is set for protocol.</p>

LAN INTERFACE MODE (TABLE 4-5)

MENU	DESCRIPTION
	<p>Is the premiere screen of the Interface Mode. The Interface Mode allows the parameters to be set</p>

Unit 4: Printer Configuration

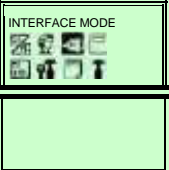
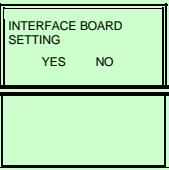
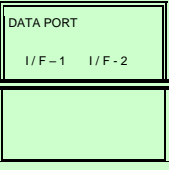
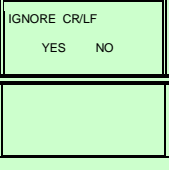
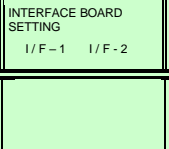
	<p>for the printer to communicate with a host and vice-versa.</p>
	<p>Select the YES option to configure an interface board for bi-directional communication, the menu will advance to multiple configuration screens depending on the type of interface board installed.</p> <p>Selecting the NO option will bypass those screens.</p>
	<p>Allows the selection of which interface port will be assigned to receive print data. Interface Port 1 (I/F-1) is not in use. Interface Port 2 (I/F-2) is the printer's middle card slot. The default setting is I/F-2 and accommodates a standard interface card.</p>
	<p>Determines whether the print data code requires deletion. Hexadecimal graphic data will not be deleted. Select YES to delete all carriage returns (CR) and line feed (LF) commands in the data stream - including graphics and 2D bar codes.</p> <p>This feature is primarily used to maintain compatibility with earlier models of SATO printers.</p>
	<p>Allows the selection of which interface board will be set up in subsequent menus. Interface Port 1 (I/F-1) is not in use. Interface Port 2 (I/F-2) is the printer's middle card slot. The default setting is I/F-2 and accommodates a standard interface card.</p>

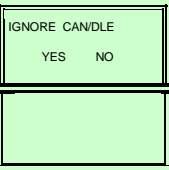
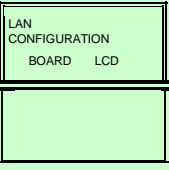
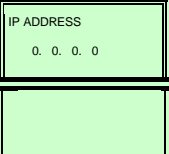
LAN INTERFACE MODE (TABLE 4-5)	
MENU	DESCRIPTION
	<p>Allows the determination of whether the Cancel (CAN) and Data Link Escape (DLE) codes will be processed or ignored. Select the YES option to ignore the codes and NO to process them.</p> <p>This screen will only appear when the communication protocol is STATUS4.</p>
	<p>Allows the determination of whether the interface will be configured on the interface board or the LCD. This screen will only appear if the LAN, Wireless LAN, or Mini LAN interface board has been installed. Power off the printer, then on again to enable the changes.</p>
	<p>Sets a unique static IP Address using the TCP/IP Protocol. The format of an IP Address is a 32bit numeric address written as four numbers separated by periods. See your network administrator for available IP Addresses.</p>

Unit 4: Printer Configuration

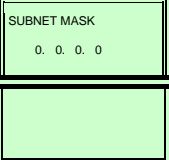
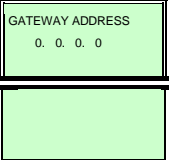
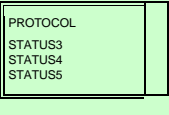
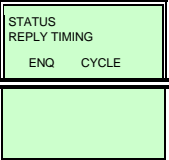
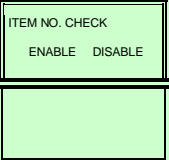
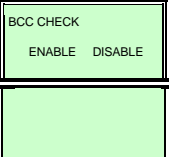
	<p>Specifies which segment of the network the printer will reside. The format of Subnet Mask is a 32bit numeric address written as four numbers separated by periods. See your network administrator to find out your Subnet Mask.</p>
	<p>Specifies the IP Address of the main router on the host network. The format of a Gateway Address is a 32-bit numeric address written as four numbers separated by periods. See your network administrator to find out your default Gateway Address.</p> <p>When the priority setting is set to BOARD, this screen will not appear. Power off the printer, then on again to enable the changes.</p>
	<p>Allows setting of the sequence of control characters to ensure correct data transference. See your network administrator to find out which Status number will be used for the control characters being sent to and from the printer.</p>
	<p>Allows reply timing of status information to the host to be set. Select the ENQ option to return status after receiving Status Request (ENQ) and CYCLE to return status from the printer to the host at 500ms intervals.</p> <p>This screen will only appear when LAN or Wireless LAN is installed and when protocol is set to STATUS4.</p>
	<p>Allows the item number check to be enabled or disabled. Will only appear when STATUS5 is set for the protocol. When performing a test print of any LAN type of interface, set this to DISABLE.</p>
	<p>Allows BCC check to be enabled or disabled. Will only appear if STATUS5 is set for protocol. When the printer driver is set for GAP sensor printing (transmissive mode), BCC CHECK will be switched to DISABLE.</p> <p>When performing a test print of any LAN type of interface, set this to DISABLE.</p>

USB INTERFACE MODE (TABLE 4-6)

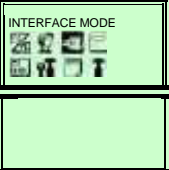
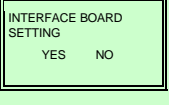

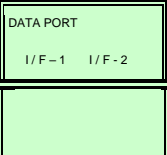
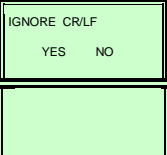
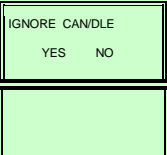
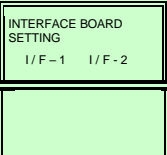
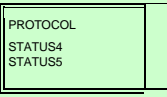
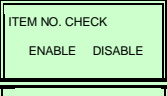
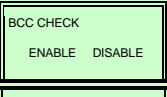

MENU	DESCRIPTION
	<p>Is the premiere screen of the Interface Mode. The Interface Mode allows the parameters to be set for the printer to communicate with a host and vice-versa.</p>
	<p>Select the YES option to configure an interface board for bi-directional communication, the menu will advance to multiple configuration screens depending on the type of interface board installed.</p> <p>Selecting the NO option will bypass those screens.</p>

Unit 4: Printer Configuration

	<p>Allows the selection of which interface port will be assigned to receive print data. Interface Port 1 (I/F-1) is not in use. Interface Port 2 (I/F-2) is the printer's middle card slot. The default setting is I/ F-2 and accommodates a standard interface card.</p>
	<p>Determines whether the print data code requires deletion. Hexadecimal graphic data will not be deleted. Select YES to delete all carriage returns (CR) and line feed (LF) commands in the data stream - including graphics and 2D bar codes.</p> <p>This feature is primarily used to maintain compatibility with earlier models of SATO printers.</p>
	<p>Allows the determination of whether the Cancel (CAN) and Data Link Escape (DLE) codes will be processed or ignored. Select the YES option to ignore the codes and NO to process them.</p> <p>This screen will only appear when the communication protocol is STATUS4.</p>
	<p>Allows the selection of which interface board will be set up in subsequent menus. Interface Port 1 (I/F-1) is not in use. Interface Port 2 (I/F-2) is the printer's middle card slot. The default setting is I/ F-2 and accommodates a standard interface card.</p>
	<p>Allows setting of the sequence of control characters to ensure correct data transference. See your network administrator to find out which Status number will be used for the control characters being sent to and from the printer.</p>
	<p>Allows the item number check to be enabled or disabled. Will only appear when STATUS5 is set for the protocol.</p>
	<p>Allows BCC check to be enabled or disabled. Will only appear if STATUS5 is set for protocol. When the printer driver is set for GAP sensor printing (transmissive mode), BCC CHECK will be switched to DISABLE.</p>

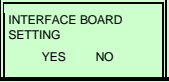
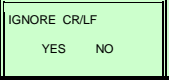
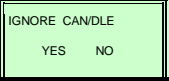
CENTRONICS INTERFACE MODE (TABLE 4-7)	
MENU	DESCRIPTION
	<p>Is the premiere screen of the Interface Mode. The Interface Mode allows the parameters to be set for the printer to communicate with a host and vice-versa.</p>

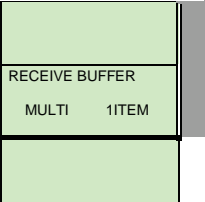
Unit 4: Printer Configuration

	<p>Select the YES option to configure an interface board for bi-directional communication, the menu will advance to multiple configuration screens depending on the type of interface board installed.</p> <p>Selecting the NO option will bypass those screens.</p>
	<p>Determines whether the print data code requires deletion. Hexadecimal graphic data will not be deleted. Select YES to delete all carriage returns (CR) and line feed (LF) commands in the data stream - including graphics and 2D bar codes.</p> <p>This feature is primarily used to maintain compatibility with earlier models of SATO printers.</p>
	<p>Allows the determination of whether the Cancel (CAN) and Data Link Escape (DLE) codes will be processed or ignored. Select the YES option to ignore the codes and NO to process them.</p> <p>This screen will only appear when the communication protocol is STATUS4.</p>
	<p>Allows the selection of which interface board will be set up in subsequent menus. Interface Port 1 (I/F-1) is not in use. Interface Port 2 (I/F-2) is the printer's middle card slot. The default setting is I/F-2 and accommodates a standard interface card.</p>
	<p>Allows the selection of the receive buffer type. Select MULTI for multiple-item buffer and 1ITEM for a single item buffer.</p>
	<p>Allows the selection of which interface port will be assigned to receive print data. Interface Port 1 (I/F-1) is not available. Always select Interface Port 2 (I/F-2).</p>
WIRELESS LAN INTERFACE MODE (TABLE 4-8)	
MENU	DESCRIPTION
	<p>Is the premiere screen of the Interface Mode. The Interface Mode allows the parameters to be set for the printer to communicate with a host and vice-versa.</p>

Unit 4: Printer Configuration

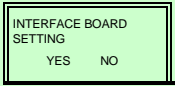
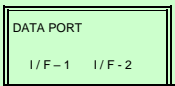
	<p>Select the YES option to configure an interface board for bi-directional communication, the menu will advance to multiple configuration screens depending on the type of interface board installed.</p> <p>Selecting the NO option will bypass those screens.</p>
	<p>Allows the selection of which interface port will be assigned to receive print data. Interface Port 1 (I/F-1) is not in use. Interface Port 2 (I/F-2) is the printer's middle card slot. The default setting is I/ F-2 and accommodates a standard interface card.</p>

WIRELESS LAN INTERFACE MODE (TABLE 4-8)

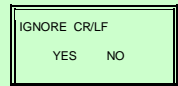
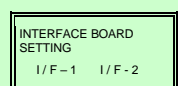
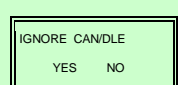
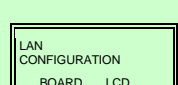
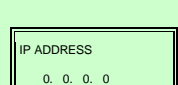
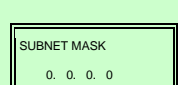
MENU	DESCRIPTION
	<p>Determines whether the print data code requires deletion. Hexadecimal graphic data will not be deleted. Select YES to delete all carriage returns (CR) and line feed (LF) commands in the data stream - including graphics and 2D bar codes.</p> <p>This feature is primarily used to maintain compatibility with earlier models of SATO printers.</p>
	<p>Allows the selection of which interface board will be set up in subsequent menus. Interface Port 1 (I/F-1) is not in use. Interface Port 2 (I/F-2) is the printer's middle card slot. The default setting is I/ F-2 and accommodates a standard interface card.</p>
	<p>Allows the determination of whether the Cancel (CAN) and Data Link Escape (DLE) codes will be processed or ignored. Select the YES option to ignore the codes and NO to process them.</p> <p>This screen will only appear when the communication protocol is STATUS4.</p>
	<p>Allows the determination of whether the interface will be configured on the interface board or the LCD. This screen will only appear if the LAN, Wireless LAN, or Mini LAN interface board has been installed. Power off the printer, then on again to enable the changes.</p>
	<p>Sets a unique static IP Address using the TCP/IP Protocol. The format of an IP Address is a 32bit numeric address written as four numbers separated by periods. See your network administrator for available IP Addresses.</p>
	<p>Specifies which segment of the network the printer will reside. The format of Subnet Mask is a 32bit numeric address written as four numbers separated by periods. See your network administrator to find out your Subnet Mask.</p>

Unit 4: Printer Configuration

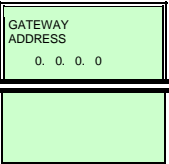
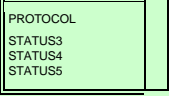
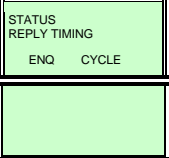
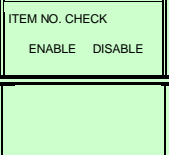
	<p>Specifies the IP Address of the main router on the host network. The format of a Gateway Address is a 32-bit numeric address written as four numbers separated by periods. See your network administrator to find out your default Gateway Address.</p> <p>When the priority setting is set to BOARD, this screen will not appear. Power off the printer, then on again to enable the changes.</p>
	<p>Allows setting of the sequence of control characters to ensure correct data transference. See your network administrator to find out which Status number will be used for the control characters being sent to and from the printer.</p>
	<p>Allows reply timing of status information to the host to be set. Select the ENQ option to return status after receiving Status Request (ENQ) and CYCLE to return status from the printer to the host at 500ms intervals.</p> <p>This screen will only appear when LAN or Wireless LAN is installed and when protocol is set to STATUS4.</p>
	<p>Allows the item number check to be enabled or disabled. Will only appear when STATUS5 is set for the protocol. When performing a test print of any LAN type of interface, set this to DISABLE.</p>

WIRELESS LAN INTERFACE MODE (TABLE 4-8)

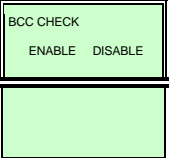
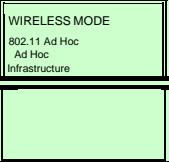
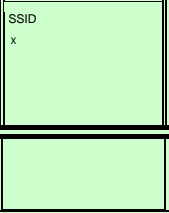
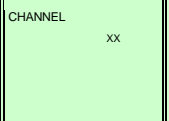
MENU	DESCRIPTION
	<p>Allows BCC check to be enabled or disabled. Will only appear if STATUS5 is set for protocol. When the printer driver is set for GAP sensor printing (transmissive mode), BCC CHECK will be switched to DISABLE.</p> <p>When performing a test print of any LAN type of interface, set this to DISABLE.</p>
	<p>This menu screen allows for the setting of the wireless LAN communication method. See your network administrator for the proper setting.</p>
	<p>Allows the unique wireless LAN SSID name to be configured in the printer. See your network administrator for proper SSID settings.</p>
	<p>Allows the wireless LAN channel to be set in the printer. The valid range is 01 to 14. See your network administrator for the wireless network channel.</p>

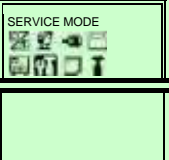
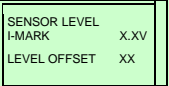
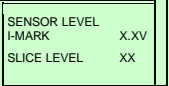
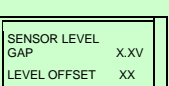
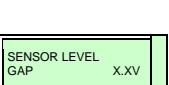
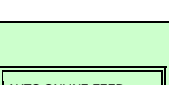
SERVICE MODE (TABLE 4-9)	
MENU	DESCRIPTION
	<p>The Service Mode allows the programming of various dimensional settings, sensor thresholds, and language options.</p>
	<p>Permits sensitivity adjustment of the eye-mark sensor. The adjustment range is 1 to 99. The default value is 50.</p>
	<p>Permits adjustment of the sensor's slice level. The slice level is the voltage at which the printer determines media change from label to gap and vice-versa.</p> <p>A setting of 0.0 to 3.2 volts is possible. The default is 1.4 volts. A setting of 0.0 volts causes the printer to automatically determine the slice level.</p>
	<p>Allows sensitivity adjustment of the gap sensor for different label materials. Increasing/ decreasing the level offset changes the sensor's voltage value within a factory set range.</p> <p>The adjustment range is 1 to 99. The default value is 50. Refer to the Adjustment Procedures section of this manual for detailed instructions.</p>
	<p>Allows the sensor threshold (slice level) adjustment of the gap sensor. Ideally, the slice level setting is at or near the mid-point between the low and high voltage readings from the previous screen ((low voltage reading + high voltage reading)/2 = slice level setting).</p> <p>A setting of 0.0 to 3.2 volts is possible. The default value is 1.2 volts. A setting of 0.0 volts causes the printer to automatically determine the slice level.</p>
	<p>This feature allows one label to be fed upon the printer entering the online mode. Enable or disable as desired.</p>

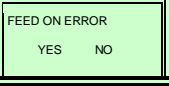
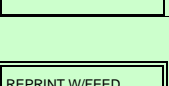

SERVICE MODE (TABLE 4-9)	
MENU	DESCRIPTION
	<p>Allows it to be determined if the printer will feed a label when an error condition is cleared and the printer goes online.</p>
	<p>This features allows the previously printed label to be reprinted when the FEED button is pressed. Enable or disable as desired.</p>

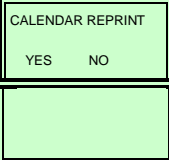
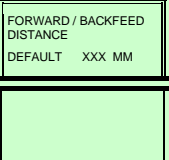
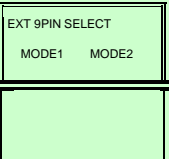
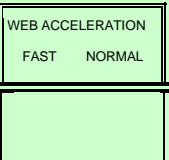
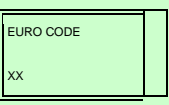
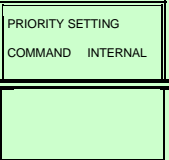
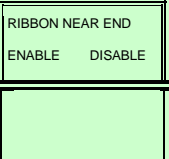
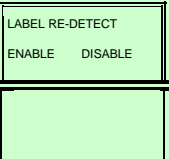
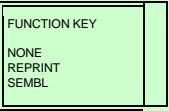
Unit 4: Printer Configuration

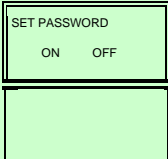
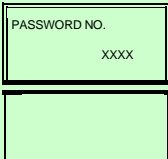
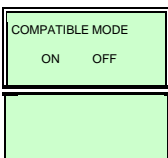
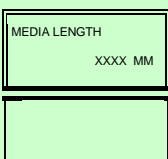
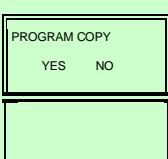
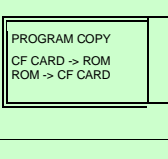
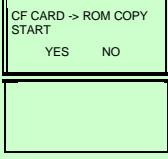
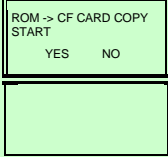
	<p>When Reprint function is enabled, this setting determines whether or not printer generated real time clock fields will be updated for reprinted labels.</p>
	<p>Allows the establishment of a specific distance the media will be advanced and retracted in addition to distance set by the OFFSET potentiometer on the operator panel. If using thermal transfer for printing, set the feed distance less than 30mm to avoid detection of the ribbon end by accident.</p>
	<p>Allows selection of output mode options. MODE1 outputs signal in the status of existence/nonexistence for the number of remaining labels to be printed. MODE2 outputs signal in the status of online/offline.</p>
	<p>Allows the printer to use either a NORMAL or FAST web acceleration. Large, heavy label rolls should use the NORMAL option while smaller, lighter rolls can use the FAST option.</p>
	<p>Allows the hexadecimal code to be specified for the character replaced with the Euro Character. The default is D5H.</p>
	<p>Allows the user to assign a method of command priority. Where programming instructions conflict, the printer will allow this assignment to take priority. This priority assignment affects the settings for print darkness, print speed, start position correction, operation mode, print method, and sensor types.</p>
	<p>Select the ENABLE option to set the printer to automatically notify when ribbon supply is nearly exhausted.</p>
	<p>Select ENABLE to allow the printer to re detect label pitch after the printer has been turned on after having the print head open. When DISABLE is selected, label pitch will not be re detected, and the label must be manually positioned.</p>
	<p>Allows the assignment of a function to the Function key. The NONE setting disables the button. It may also be assigned the REPRINT command or to enter the SEMBL mode.</p>

SERVICE MODE (TABLE 4-9)	
MENU	DESCRIPTION
	Permits the determination of whether a password will be required to access and change principle configuration features.
	Permits the assignment of a password. Use the vertical arrow keys of the operator panel to scroll digit options and the horizontal arrow keys to move from one digit location to another. Press the Enter key to record the four-digit password chosen.
	Determines whether or not the printer will be compatible with a previous printer model. When the Compatibility Mode is ON, the functions and settings that are unique to the printer will be disabled or modified to match the characteristics of older printer models of the same family. This allows legacy or custom-programmed labeling software to run on this printer without requiring modification.
	Allows the maximum length of the label used to be defined. The default value varies depending on head density: 8dot/mm = 0 to 2500mm, 12dot/mm = 0 to 1500mm, 24dot/mm = 0 to 400mm. This screen will not appear if the Compatibility Mode has been turned ON.
	Allows the determination of copying firmware data to and from the ROM and optional CF Card. The default setting is NO, meaning that copying is not desired.
	Appears if the YES option was chosen on the preceding screen and allows the direction of information flow to be determined.
	This screen confirms the selection from the preceding screen and allows the option of initiating the copy or to abort.
	This screen confirms the selection from the preceding screen and allows the option of initiating the copy or to abort.

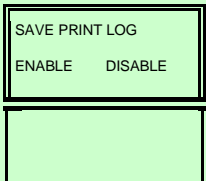
Unit 4: Printer Configuration

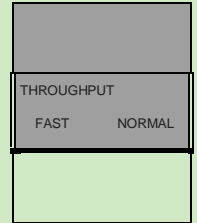
	<p>Permits determination of whether a record of print activity will be maintained on the CF Card.</p>
	<p>Sets ribbon tension. Higher value equals lower tension.</p>
	<p>This screen allows the user to change the printer's delay timing to improve throughput. Selecting FAST will decrease printer's delay timing and improve label throughput.</p>

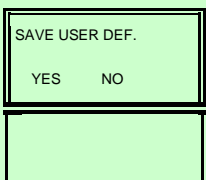
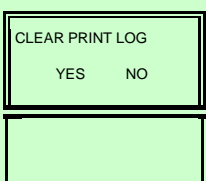
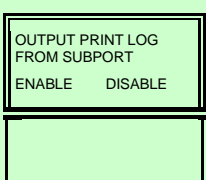
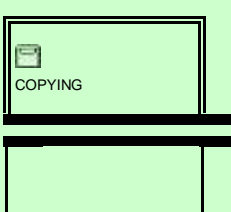
<p align="center">SERVICE MODE (TABLE 4-9)</p>	
<p align="center">MENU</p>	<p align="center">DESCRIPTION</p>
	<p>When "YES" is selected, all printer menu settings will be saved in a file that can later be recalled via the Default Setting Mode.</p>
	<p>Allows the record of print activity to be cleared if a log has been maintained.</p>
	<p>Allows the print log to be output to the printer's sub-port (port not used for print data) in real time. The default is DISABLE.</p>
	<p>Screen confirms that copying is in process and displays its progress status. A tinted field will move laterally from the left toward the right as copying progresses. When the tinted bar reaches 100 on the scale, copying is complete.</p>

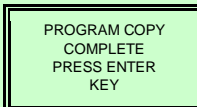
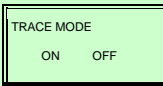
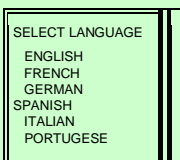

Unit 4: Printer Configuration

	<p>This screen confirms the completion of the copy process and prompts for action to exit the program.</p>
	<p>If Trace Mode is enabled, three different icons will appear on the LCD to trace the processing of a label. The first identifies data reception, the second displays after receiving <ESC>A (1BH), and the third displays following a print operation.</p>
	<p>Allows the language of the menu screens to be selected.</p>

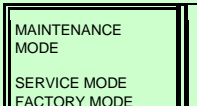
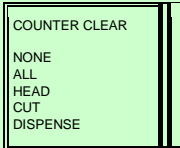
FACTORY MODE (TABLE 4-10)

MENU	DESCRIPTION
	<p>Is the first menu screen of the Maintenance Mode that includes the Service Mode and Factory Mode. Provides a prompt on the action required to proceed to the Factory Mode.</p>
	<p>Counter Clear permits the operator to select individual counters to be reset to zero or by selecting ALL, to entirely clear all of the printer's internal counters or EEPROM data.</p>

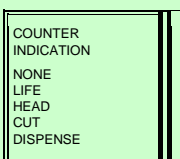
FACTORY MODE (TABLE 4-10)

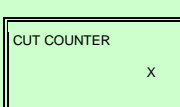

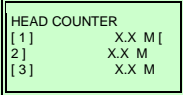
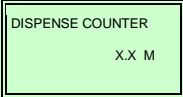
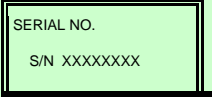
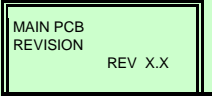
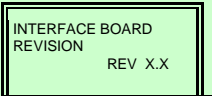
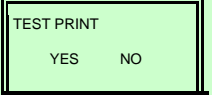
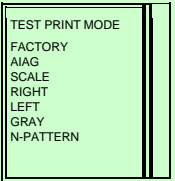

MENU	DESCRIPTION
	<p>Allows view of the recorded linear meters of printed media by the printer's internal counters.</p>
	<p>Is an informational screen that provides the length of media used since printer setup.</p>
	<p>Enables view of the printer's cutter counter identifying the quantity of cut cycles by that cutter.</p>

Unit 4: Printer Configuration

	<p>Is an informational screen that provides the printed length of media using the existing print head. The head counter should be reset each time the print head is replaced.</p>
	<p>Enables view of the printer's dispense counter identifying the quantity of times the printer has dispensed a label.</p>
	<p>Enables the printer's serial number to be recorded within its memory.</p>
	<p>Enables the revision number of the main circuit board to be recorded within its memory.</p>
	<p>Enables the revision number of the interface board to be recorded within its memory.</p>
	<p>Allows the determination of whether to test print or not.</p>
	<p>If the YES option is selected from the previous screen, this menu allows the test print type to be selected.</p>

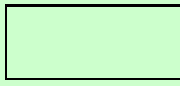
<p align="center">FACTORY MODE (TABLE 4-10)</p>	
<p align="center">MENU</p>	<p align="center">DESCRIPTION</p>
	<p>Allows the selection of large (10cm) or small (4cm) media width. These are the only two options.</p>

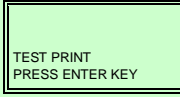
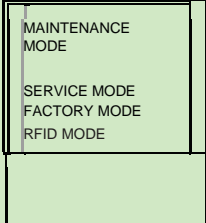
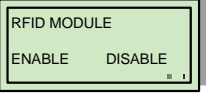
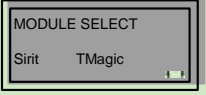
Unit 4: Printer Configuration

	
	<p>This screen shows the setting of factory pitch volume.</p> <p>This setting screen is displayed for VA/VE substrate only when performing test print. Press ENTER to start test print.</p> <p>Use ↑ and ↓ keys to change factory offset value, and its range is between -3.75 and +3.75. Printing operation can be stopped temporarily by pressing ENTER while printing.</p>
	<p>Initiates test printing activity.</p>
<p>FACTORY MODE WITH RFID INSTALLED (TABLE 4-11)</p>	
<p>MENU</p>	<p>DESCRIPTION</p>
	<p>This is the first menu screen of the Factory Mode with RFID Installed. It includes the Service Mode, Factory Mode, and RFID Mode. Provides a prompt on the action required in order to proceed to the Factory Mode with RFID Installed.</p>
	<p>This screen permits the operator to enable or disable the RFID Module.</p>
	<p>This screen allows selection of the installed RFID module type.</p>
	<p>This screen allows selection of the RFID frequency band for the specific geographic location.</p>

<p>RFID USER MODE (TABLE 4-12)</p>	
<p>MENU</p>	<p>DESCRIPTION</p>

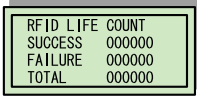
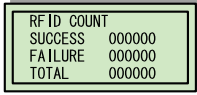
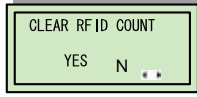
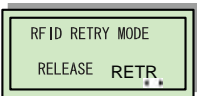
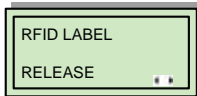
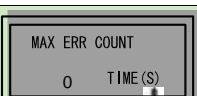

Unit 4: Printer Configuration

	<p>Showing the total accumulated number of RFID writes.</p> <p>SUCCESS: Shows the number of write success to RFID tag.</p> <p>FAILURE: Shows the number of write failure to RFID tag.</p> <p>TOTAL: Shows the total write quantity.</p> <p>[Total quantity of successful writes] + [total quantity of write failures] = Total RFID Writes</p> <p>The counters can be reset by performing a Factory Clear operation.</p>
	<p>Showing the total number of RFID writes.</p> <p>SUCCESS: Shows the number of write success to RFID tag.</p> <p>FAILURE: Shows the number of write failure to RFID tag.</p> <p>TOTAL: Shows the total number of writes.</p> <p>[Total quantity of successful writes] + [total quantity of write failures] = Total RFID Writes</p>
	<p>Initializing RFID current counter.</p> <p>Selecting YES and pressing FEED button will initialize the RFID current counter (SUCCESS, FAIL, or TOTAL).</p> <p>The initial value is NO.</p> <p>Note: The RFID life counter(s) cannot be reset through this screen.</p>
	<p>Setting the printer motion at the time of RFID tag error. Also, this section shows how to recover from an RFID ERROR state when the error count exceeds the specified limit.</p> <p>RELEASE: The printer keeps writing tags and discarding defective tags up to a specified quantity even when a tag error occurs. Then the printer emits a RFID ERROR message and pauses the operation when the error count exceeds the specified limit.</p> <p>RETRY: When a tag error occurs, the printer attempts to write the same data based on the specified quantity. If the tag writing still fails, the printer emits a RFID ERROR message and pauses the operation.</p> <p>The initial value is RETRY.</p> <p>This screen is displayed only when MODULE SELECT is set to ThingMagic in the Service Mode.</p>
	<p>Allows the selection of the printer's action following a write failure. The RELEASE option deletes the current job so the printer may advance to next print job. Choosing the RETRY option instructs the printer to continue attempting to write the same data until it succeeds or until an error (MAX ERR CNT) occurs.</p> <p>Use the printer's operator panel to scroll and select the desired option.</p>
	<p>Setting the counter for void and reprint tags at the time of tag error.</p> <p>Input range is from 0 to 9.</p> <p>The initial value is 0.</p>

RFID USER MODE (TABLE 4-12)

MENU	DESCRIPTION
------	-------------

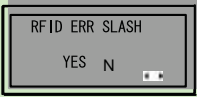
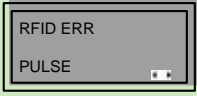
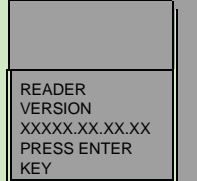
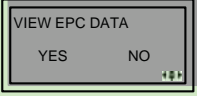
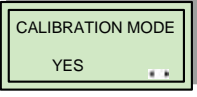
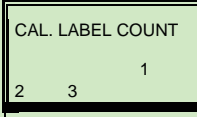
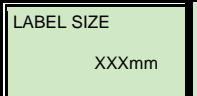
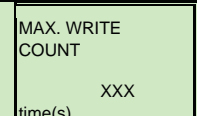

Unit 4: Printer Configuration

	<p>Printing a slash on a tag when an RFID tag error occurred. YES: Prints a slash at the time of RFID tag error. NO: Not printing a slash at the time of RFID tag error. The initial value is NO.</p>
	<p>Allows the selection of the output pattern of RFID error. Selecting PULSE will result in a single pulsating output and selecting LEVEL will result in a flat output. Use the printer's operator panel to scroll and select the desired option.</p>
	<p>Displays the Firmware version of the RFID module. Use the printer's operator panel to advance to the next menu screen.</p>
	<p>Allows the determination of whether or not the EPC data will be viewed in the inlay which is currently in the antenna's read position. Use the printer's operator panel to scroll and select the desired option.</p>
	<p>The Calibration Mode allows calibration of the RFID transponder. If using RFID labels that are printer specific, RFID transponder calibration is not necessary because the printer will automatically place the labels in the optimal programming position. Contact SATO America Technical Support for inlay + placement specifications as necessary. Where printer specific RFID labels are not to be used or in cases of new inlay types, RFID calibration may be required to determine the optimal programming position and transmission/reception power conducive to that media.</p>
	<p>Allows the selection of the label quantity to be used for calibration. A measurement will occur for each label to create a ratio of variance in determining the nominal. A report will be issued. Use the printer's operator panel to scroll and select the desired option.</p>
	<p>Allows the determination of label length to be used for calibration purposes. Use the printer's operator panel to scroll and select the desired setting. The increments are in millimeters.</p>
	<p>Allows the determination of the maximum quantity of write attempts at a single position. Use the printer's operator panel to scroll and select the desired attempts.</p>
	<p>Allows the selection of the calibration start power.</p>

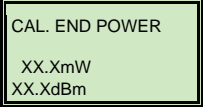
Unit 4: Printer Configuration

	<p>Allows the selection of the calibration end power.</p>
---	---

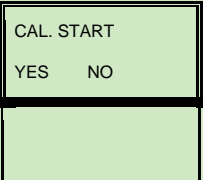
RFID USER MODE (TABLE 4-12)

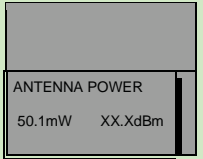
MENU	DESCRIPTION
	<p>Allows the initialization of calibration. Ensure the printer is loaded with the intended media to be calibrated. Use the printer's operator panel to scroll and select the desired option.</p>
	<p>Setting the RFID tag position from the top of form. The input range is between 0.79" (20 mm) and 9.45" (240 mm). The initial value is 0.79" (20 mm). The measurement units are millimeters.</p>
	<p>Allows for the determination of the antenna's reception power when calibrating.</p>

WORK SHIFT MODE (TABLE 4-13)

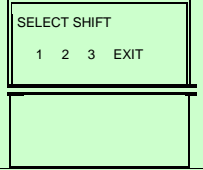
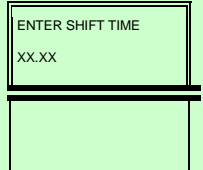
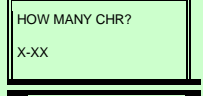
MENU	DESCRIPTION
	<p>This screen is used to select the shift that will be configured in the screens to follow. Up to three shifts can be configured. Note the shift code must be installed from within the Hidden Mode (below) to access the Work Shift Mode.</p>
	<p>Permits the entry of the begin time of the shift being configured. This is in a 24 hour clock format.</p>
	<p>Allows the establishment of the quantity of character to be used for the Shift Name in the screen to follow. The first X depicts the shift number and is based upon what was selected in the Select Shift screen. The XX has a valid range of 1 to 16.</p>

Unit 4: Printer Configuration

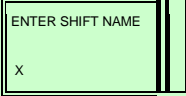
	<p>Allows the entry of the user defined shift name. The quantity of characters used must be reflective of the quantity entered in the preceding screen.</p>
---	---

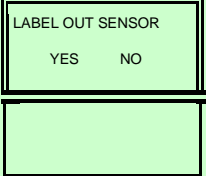

HIDDEN MODE (TABLE 4-14)

MENU	DESCRIPTION
	<p>Used to enable or disable the label out sensor. The YES option is enabled and the NO option is disabled.</p>

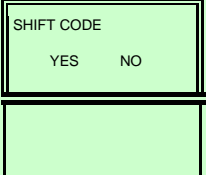
HIDDEN MODE (TABLE 4-14)

MENU	DESCRIPTION
	<p>Used to enable or disable the Shift Code menu parameters. The YES option is enabled and the NO option is disabled. Note the YES option must be selected to access the Work Shift Mode menu.</p>

DOWNLOAD MODE (TABLE 4-15)

MENU	DESCRIPTION
	<p>Is an informational screen only and confirms that the printer is ready to receive the data.</p>
	<p>Screen confirms that downloading is in process and displays its progress status. A tinted field will move laterally from the left toward the right as downloading progresses. When the tinted bar reaches 100 on the scale, downloading is complete.</p>
	<p>This menu screen appears when all of the data has been received and the process is complete.</p>

BOOT DOWNLOAD MODE (TABLE 4-16)

MENU	DESCRIPTION
-------------	--------------------

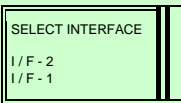
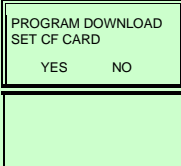
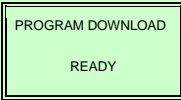
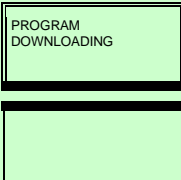

Unit 4: Printer Configuration

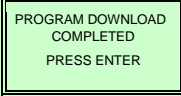
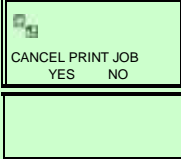
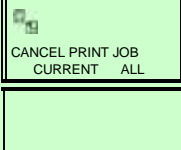
	<p>Allows the selection of location of download, via the INTERFACE or CF Card.</p>
	<p>Permits the sub-port to be used for the download process. The I/F-1 port is not in use. I/F-2 is the standard interface type. This screen only appears if INTERFACE was selected in the first screen.</p>
	<p>This screen only appears if CARTRIDGE was selected in the first screen and prompts to confirm that the CF Card has been installed and set up for use.</p>
	<p>Confirms the printer is on standby for receiving data.</p>
	<p>Screen confirms that downloading is in process and displays its progress status. A tinted field will move laterally from the left toward the right as downloading progresses. When the tinted bar reaches 100 on the scale, downloading is complete.</p>

<p align="center">BOOT DOWNLOAD MODE (TABLE 4-16)</p>	
<p align="center">MENU</p>	<p align="center">DESCRIPTION</p>
	<p>This menu screen appears when all of the data has been received and the process is complete. Also prompts the operator on how to proceed.</p>
<p align="center">PRINT CANCEL MODE (TABLE 4-17)</p>	
<p align="center">MENU</p>	<p align="center">DESCRIPTION</p>
	<p>Print data that has been previously received, can be cleared. If the YES option is selected, the print data will be deleted and then the printer will go offline. If the NO option is selected, the printer will go offline without deleting data.</p>
	<p>This menu screen allows the selection of whether to only delete the current print job or all that have been received.</p>

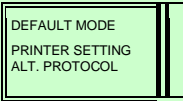
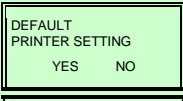
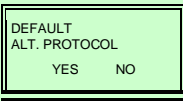
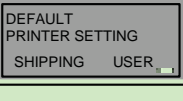
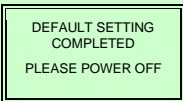
Unit 4: Printer Configuration

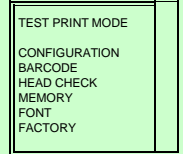
	<p>This screen confirms the received data has been deleted. Will display for 3 seconds, then the printer will go offline.</p>
DEFAULT SETTING MODE (TABLE 4-18)	
MENU	DESCRIPTION
	<p>Is the first menu screen of the printer's Default Setting Mode. The Default Setting Mode allows the printer to be reset to the programmed condition as received from the factory. This may include all printer settings or just protocol.</p>
	<p>The selection of YES confirms the operator wants to proceed and the selection of NO allows for exit without default reset. If YES is selected, resetting will immediately begin. This screen will only appear if PRINTER SETTING was selected from the first screen.</p>
	<p>The selection of YES confirms the operator wants to proceed and the selection of NO allows for exit without default reset. If YES is selected, resetting will immediately begin. This screen will only appear if ALT. PROTOCOL was selected from the first screen.</p>
	<p>This screen allows the selection of either Shipping or User.</p>
	<p>Is an informational screen only indicating that reset activity is complete.</p>

TEST PRINT MODE (TABLE 4-19)	
MENU	DESCRIPTION
	<p>Is the initial screen of the Test Print Mode.</p> <ul style="list-style-type: none"> • CONFIGURATION: The printer's configuration settings. • BARCODE: The printer's installed barcodes. • HEAD CHECK: A pattern to check print head elements. • MEMORY: The printer's internal memory. • FONT: The contents of the installed fonts. • FACTORY: A factory test label will be printed.
	<p>This menu screen only appears if CONFIGURATION, BARCODE, or HEAD CHECK was chosen in the previous menu. The increments of measure is 1cm.</p>

Unit 4: Printer Configuration

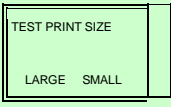
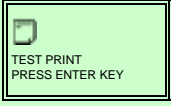
	<p>For factory test prints, this screen appears instead of the previous screen for setting print size. Large (10cm) and small (4cm) are the only two options.</p>
	<p>Is a directional screen prompting action on how to terminate print activity. Press FEED to stop printing and press again to resume printing. If the external signal is enabled, the test print must be initiated with a print start signal via the EXT port.</p>

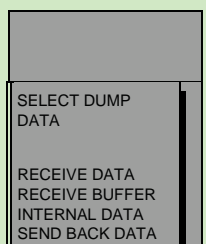
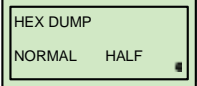
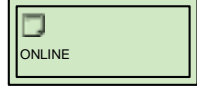

HEX DUMP MODE (TABLE 4-20)

MENU	DESCRIPTION
	<p>Is the premiere screen to the Hex Dump Mode. The contents of the print buffer and the data received before it is placed into the print buffer may be examined through the use of the Hex Dump Mode. Each line of the printed data is enumerated in the first column, the second column contains the data in hexadecimal format, and the right column contains the same data in ASCII format.</p>
	<p>Only one type of data will be printed at a time. This screen allows the selection of the data to be printed. Repeat the Hex Dump process to print the other data types if required. The INTERNAL DATA option allows the printing of setting for the internal buffer.</p>
	<p>This screen shows how to set HEX Dump Print Width. NORMAL : Printing 16 bytes received data per one line HALF : Printing 8 bytes received data per one line Use ← and → buttons to move the cursor, and then press ENTER. The initial value is NORMAL.</p>
	<p>When executing the printing of HEX dump within buffer and internal buffer data, it goes to Normal Mode automatically after printing.</p>

CF (COMPACT FLASH) CARD MODE (TABLE 4-21)

MENU	DESCRIPTION
	<p>Is the premiere screen of the CF Card Mode. The Card Mode allows management of the optional Compact Flash Card.</p>

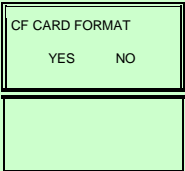
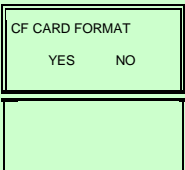
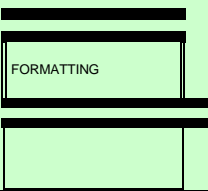
Unit 4: Printer Configuration

	<p>Allows the determination of formatting the flash card. Select the YES option to advance to the formatting screens. Select the NO option to return to the first screen of the CF Card Mode.</p>
	<p>This menu screen initiates the formatting process when selecting the YES option. Select the NO option to return to the first screen of the CF Card Mode.</p>
	<p>Screen confirms that formatting is in process and displays its progress status. A tinted field will move laterally from the left toward the right as formatting progresses. When the tinted bar reaches 100 on the scale, formatting is complete.</p>
	<p>Confirms that formatting has completed and prompts for action to exit the CF Card Mode.</p>

STAND ALONE MODE (TABLE 4-22)

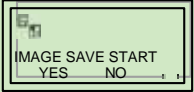
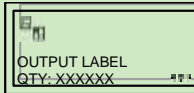
MENU	DESCRIPTION
	<p>Allows a previously sent data item to be saved. If the YES option is chosen, an image is saved to the Flash Card. If NO, is chosen, an image is not saved. Only a single image may be saved at a time and will be overwritten by a new image.</p>
	<p>Allows the data saved in the Flash Card to be read and to specify the print quantity. Use the arrow keys to change the print quantity, then press ENTER. The print will beep if print data is not stored.</p>

SZPL EMULATION MODE (TABLE 4-23)

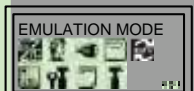

MENU	DESCRIPTION
	<p>This is the opening screen of the SZPL Emulation Mode. The SZPL Emulation Mode was created to emulate the existing Zebra print LCD menu options and to provide similar functionality.</p>

SZPL EMULATION MODE (TABLE 4-23)

MENU	DESCRIPTION
	Emulation mode select

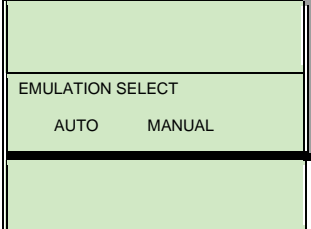
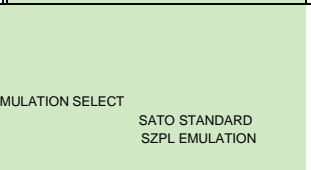
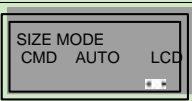
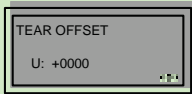
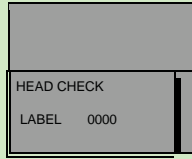
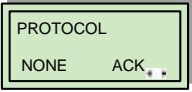
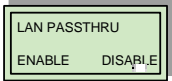
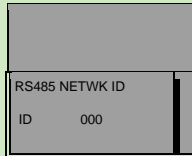
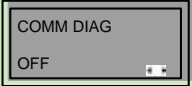
Unit 4: Printer Configuration

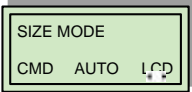
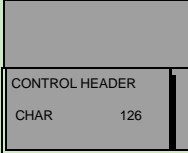
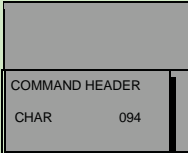
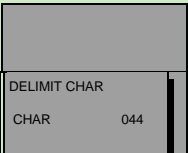
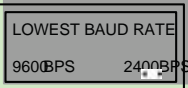
	<p>AUTO or MANUAL. Default value is AUTO.</p> <p>←, → Select AUTO or MANUAL</p>
	<p>↓, ↑ Select SATO STANDARD or SZPL EMULATION.</p>
	<p>←, → Select CMD or AUTO or LCD.</p>
	<p>Tear Offset Position</p> <p>Range is -999 to +999. Default value is +0</p> <p>←, → Select between sign (+/-) and numeric value</p> <p>↓, ↑ Change the select setting</p>
	<p>Head Check</p> <p>Range 0000-9999. Default value is 0000 (i.e. disabled)</p> <p>↓, ↑ Select 0000-9999</p>
	<p>SZPL Communication Protocol</p> <p>NONE, ACK or ZEBRA. Default value is NONE</p> <p>←, → Select NONE, ACK or ZEBRA</p> <p>Note: When the protocol is set to ACK, the status will be returned back to host (ACK/NAK) in every command execution. When protocol set to ZEBRA, the status will be returned back to host when LAN interface is used.</p>
	<p>LAN Passthru</p> <p>ENABLE or DISABLE. Default is DISABLE</p> <p>←, → Select ENABLE or DISABLE</p> <p>ENTER: Accept setting and advance to next menu</p> <p>CANCEL: Disregard setting and revert back to previous menu</p>
	<p>RS-485 Network ID</p> <p>Range 000-999. Default value is 000 (i.e. unused)</p> <p>↓, ↑ Select 000-999</p>
	<p>Communication Diagnostics (i.e. Hex Dump Mode) Default value is OFF</p> <p>←, → Select OFF or ON</p>

SZPL EMULATION MODE (TABLE 4-23)	
MENU	DESCRIPTION
	<p>Size Mode CMD/AUTO/LCD. Default value is AUTO.</p> <p>←, → Select CMD, AUTO or LCD</p> <p>Note: When AUTO is selected in Size mode, the printer will automatically feed 2 blank labels during power on stage to calibrate correct label size. If AUTO ONLINE FEED LCD under Service mode is set to NO, Size mode will switch to CMD automatically.</p>
	<p>Control Header Character Range 000 (00H)-255 (FFH). Default value is 126 (7EH)</p> <p>↓, ↑ Select 000-255</p>
	<p>Command Head Character Range 000 (00H)-255 (FFH). Default value is 094 (5EH)</p> <p>↓, ↑ Select 000-255</p>
	<p>Delimit Character Range 000 (00H)-255 (FFH). Default value is 044 (2CH)</p> <p>↓, ↑ Select 000-255</p>
	<p>Lowest Baud Rate (for serial communication only) 9600/2400 bps. Default value is 9600bps</p> <p>←, → Select 9600 BPS or 2400 BPS</p>
	<p>Selects active code page Default value is 850</p> <p>←, → Select 850 or ISO 8859-1</p>

This page is intentionally left blank.



5

TROUBLESHOOTING



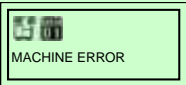

- Error Signal Troubleshooting
- Warning Signal Troubleshooting
- Troubleshooting Table
- Interface Troubleshooting
- Test Print Modes

TROUBLESHOOTING

ERROR SIGNAL TROUBLESHOOTING

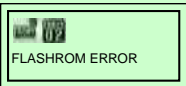
ERROR DISPLAYS			
ERROR	LED DISPLAY	LCD DISPLAY	DESCRIPTION
01 Machine Error	POWER: On ONLINE: Off LABEL: Off RIBBON: Off		<ol style="list-style-type: none"> 1. Ensure all wiring harnesses are properly connected. 2. Replace main circuit board as necessary.
02 Machine Error	POWER: On ONLINE: Off LABEL: Off RIBBON: Off		<ol style="list-style-type: none"> 1. Ensure work environment does not exceed specification. 2. Ensure fan filter is not clogged. Replace as necessary. 3. Ensure internal fan is operational. Replace as necessary. 4. Replace main circuit board as necessary.



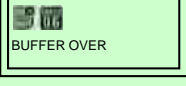
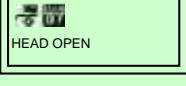
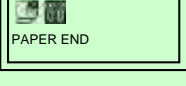

Unit 5: Troubleshooting

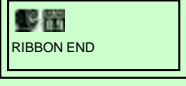
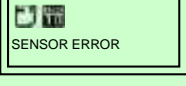
03 Flash ROM Error	POWER: On ONLINE: Off LABEL: Off RIBBON: Off	 FLASHROM ERROR	<ol style="list-style-type: none"> 1. Ensure correct communication protocols. 2. Check cables, cycle printer power and resend. 3. Replace board as necessary.
04 Parity Error	POWER: On ONLINE: Blink LABEL: Off RIBBON: Off	 PARITY ERROR	<ol style="list-style-type: none"> 1. Ensure correct communication parameters. 2. Check cables, cycle printer power and resend. 3. Replace board as necessary.
05 Overrun Error	POWER: On ONLINE: Blink LABEL: Off RIBBON: Off	 OVERRUN ERROR	<ol style="list-style-type: none"> 1. Check and correct communication cables and settings.
06 Framing Error	POWER: On ONLINE: Blink LABEL: Off RIBBON: Off	 FRAMING ERROR	<ol style="list-style-type: none"> 1. Ensure host system and interface settings match. 2. Check and correct communication cables. (null modem serial cable required)
07 Buffer Overflow Error	POWER: On ONLINE: Blink LABEL: Off RIBBON: Off	 BUFFER OVER	<ol style="list-style-type: none"> 1. Size of received data exceeds size of receiving buffer. 2. Establish the correct communication protocol.
08 Head Open Error	POWER: On ONLINE: Off LABEL: Off RIBBON: Off	 HEAD OPEN	<ol style="list-style-type: none"> 1. Properly latch the print head. 2. Replace the head-open switch.
09 Paper End Error	POWER: On ONLINE: Off LABEL: Off RIBBON: On	 PAPER END	<ol style="list-style-type: none"> 1. Ensure media is properly loaded. 2. Clean sensor transmit/receive surfaces. 3. Ensure correct sensor configuration.

ERROR DISPLAYS

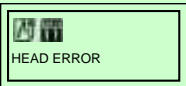
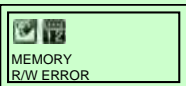

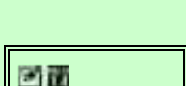
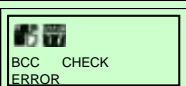
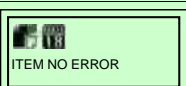
ERROR	LED DISPLAY	LCD DISPLAY	DESCRIPTION
10 Ribbon End Error	POWER: On ONLINE: Off LABEL: Off RIBBON: On	 RIBBON END	<ol style="list-style-type: none"> 1. Ensure ribbon stock is properly loaded. 2. Ensure ribbon has not been damaged. 3. Ensure proper printer configuration.
11 Sensor Error	POWER: On ONLINE: Off LABEL: Off RIBBON: Off	 SENSOR ERROR	<ol style="list-style-type: none"> 1. Ensure media is properly loaded. 2. Clean sensor transmit/receive surfaces. 3. Ensure correct sensor configuration. 4. Replace sensor as necessary.

Unit 5: Troubleshooting





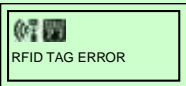
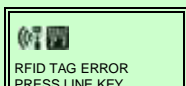

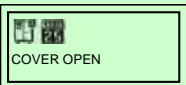
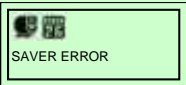

12 Head Related Error	POWER: On ONLINE: Blink LABEL: Off RIBBON: Off		<ol style="list-style-type: none"> 1. Clean the print head's contact surface. 2. Replace the print head.
13 Memory Reading Error	POWER: On ONLINE: Off LABEL: Off RIBBON: Off		<ol style="list-style-type: none"> 1. Ensure CF Card is properly installed. 2. Format CF Card.
14 Memory Full Error	POWER: On ONLINE: Off LABEL: Off RIBBON: Off		<ol style="list-style-type: none"> 1. Delete unnecessary data from flash card. 2. Ensure proper download data size.
15 Download Data Error	POWER: On ONLINE: Off LABEL: Off RIBBON: Off		<ol style="list-style-type: none"> 1. Ensure proper download data size.
16 BCC Check Error	POWER: On ONLINE: Blink LABEL: Off RIBBON: Off		<ol style="list-style-type: none"> 1. Ensure correct send data and communication settings.
17 Item Number Error	POWER: On ONLINE: Blink LABEL: Off RIBBON: Off		<ol style="list-style-type: none"> 1. Ensure correct send data and communication settings.
18 Head Mismatch Error	POWER: On ONLINE: Off LABEL: Off RIBBON: Off		<ol style="list-style-type: none"> 1. Ensure correct print head installation. 2. Ensure correct printer configuration for print head.
19 Kanji ROM Error	POWER: On ONLINE: Off LABEL: Off RIBBON: Off		<ol style="list-style-type: none"> 1. Ensure correct Kanji ROM installation. 2. Replace the board as necessary.

ERROR DISPLAYS			
ERROR	LED DISPLAY	LCD DISPLAY	DESCRIPTION
20 Calendar Error	POWER: On ONLINE: Off LABEL: Off RIBBON: Off		<ol style="list-style-type: none"> 1. Power off the printer to release the error. 2. Reinstall the calendar chip. 3. Replace the main circuit board as necessary.





Unit 5: Troubleshooting

21 RFID Error	POWER: On ONLINE: Off LABEL: Off RIBBON: Off		<ol style="list-style-type: none"> 1. Write another RFID tag. 2. Ensure proper RFID setup/installation.
	POWER: On ONLINE: Off LABEL: Off RIBBON: Off		<ol style="list-style-type: none"> 1. Press the LINE key to clear. 2. Write another RFID tag. 3. Ensure proper RFID setup/installation.
	POWER: On ONLINE: Off LABEL: Off RIBBON: Off		<ol style="list-style-type: none"> 1. Write another RFID tag. 2. Ensure proper RFID setup/installation.
22 Cover Open Error	POWER: On ONLINE: Off LABEL: Off RIBBON: Off		<ol style="list-style-type: none"> 1. Ensure the cover is completely closed. 2. Ensure the cover-open switch is properly positioned. 3. Replace the switch as necessary.
23 Saver Error	POWER: On ONLINE: Off LABEL: Off RIBBON: Off		<ol style="list-style-type: none"> 1. Reset the head stop position.



ERROR ICONS



LCD ICONS	DESCRIPTION OF ERROR	POSITION ON LCD
	Displayed when detecting Label End.	Icon 1
	Displayed when detecting Ribbon End.	Icon 1
	Displayed when detecting Sensor Error.	Icon 1
	Displayed when detecting Head Open.	Icon 1
	Displayed when head is disconnected.	Icon 1
	Displayed when detecting Communication Error.	Icon 1
	Displayed when detecting Receive Buffer Over.	Icon 1
	Displayed when detecting Item No. Error or BCC Error.	Icon 1
	Displayed when having access error to CF (Compact Flash) Card.	Icon 1

Unit 5: Troubleshooting

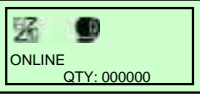
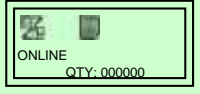
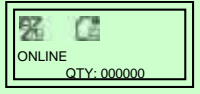
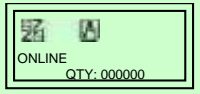
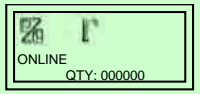
	Displayed when having write error to main ROM or when detecting Kanji ROM error.	Icon 1
	Displayed when detecting Calendar Error.	Icon 1
	Displayed when having a write error to RFID tag.	Icon 1
	Displayed when printer error other than above is detected.	Icon 1
	Displayed error number corresponding to various errors.	Icon 2

WARNING SIGNAL TROUBLESHOOTING

WARNING DISPLAYS			
WARNING	LED DISPLAY	LCD DISPLAY	DESCRIPTION
01 Ribbon Near-End Warning	POWER: On ONLINE: On LABEL: Off RIBBON: Blink		<ol style="list-style-type: none"> Limited ribbon quantity remaining. Monitor and reload before all is used.
02 Receive Buffer Near-Full Warning	POWER: On ONLINE: On LABEL: Off RIBBON: Off		<ol style="list-style-type: none"> Little receive buffer capacity remaining. Cease data transmission until existing data is analyzed.
03 Command Warning	POWER: On ONLINE: On LABEL: Off RIBBON: Off		<ol style="list-style-type: none"> Review print data for command error.
04 Head Error Warning	POWER: On ONLINE: On LABEL: Off RIBBON: Off		<ol style="list-style-type: none"> Ensure print head is connected. Replace print head.
05 Overheat Warning	POWER: On ONLINE: On LABEL: Blink RIBBON: Blink		<ol style="list-style-type: none"> Ensure work environment does not exceed specifications. Ensure fan filter is not clogged. Replace as necessary. Ensure internal fan is operational. Replace as necessary. Replace main circuit board as necessary.
WARNING ICONS			
ICON	DESCRIPTION		POSITION ON LCD
	Displayed when detecting Ribbon Near End.		Icon 3 to 5
	Displayed when detecting Buffer Near Full.		Icon 3 to 5

	Displayed when detecting Command Error.	Icon 3 to 5
	Displayed when head is disconnected.	Icon 3 to 5
	Displayed when the printer's internal temperature exceeds 85 degrees C.	Icon 3 to 5

TROUBLESHOOTING TABLE

TROUBLESHOOTING TABLE	
IMAGE VOIDS	
Dirty print head.	Clean print head.
Damaged print head.	Replace print head.
Damaged electronics.	Replace circuit board.
Damaged or worn roller.	Replace rollers.
Poor label quality.	Use higher quality media.
Ribbon stock and media are mismatched.	Consult with media supplier.
RIBBON WRINKLING	
Poor head alignment.	Adjust head balance and alignment.
Excessive temperature setting	Adjust temperature.
Poor ribbon tension.	Adjust tension as required.
Worn roller.	Replace as necessary.
Foreign material on print head and/or rollers.	Clean as required.
Foreign material on labels.	Use higher quality media.
Damaged print head.	Replace print head as required.
LIGHT PRINT IMAGES	
Low print head energy/darkness.	Adjust darkness level.
Low print head pressure.	Adjust head pressure and/or balance.
Foreign material on print head.	Clean print head and rollers.
Improper head alignment.	Align print head as required.
Excessive print speed.	Reduce print speed setting.
UNEVEN PRINT DARKNESS	
Unbalanced print head.	Adjust head balance.
Worn rollers.	Replace rollers as required.
Dirty print head.	Clean print head.
MEANDERING MEDIA	
Incorrectly loaded media.	Ensure correct loading.
Improperly adjusted media guides.	Adjust as required.
Unbalanced print head.	Adjust as required.
Worn rollers.	Replace as required.

NO LABEL MOVEMENT	
Loose or broken timing belt.	Replace or adjust as required.
Incorrect label sensor selected.	Check printer configuration for proper sensor selection.
No voltage output.	Replace fuse. Test power supply and replace as required.
Drive motor not operating.	Ensure wiring harness connection. Replace as necessary.
LCD FIELD ILLUMINATED BUT WITHOUT WORDS OR NO DISPLAY AT ALL	
Power supply issues.	Ensure cable properly connected. Check/replace power supply.
Incorrectly positioned display potentiometer.	Adjust as required.

NO PRINTED IMAGE	
Print head is disconnected.	Ensure print head wiring harness is connected on each end.
No voltage output.	Replace fuse. Test power supply and replace as required.
Defective print head.	Replace print head and reset counter.
Damaged electronics.	Replace circuit board.
Interface problems.	Troubleshoot interface - refer to the next section of this chapter.
Data input error.	Ensure correct data stream.
Ribbon incorrectly loaded.	Ensure ribbon is properly loaded.
PRINTER CREATES A BLANK LABEL.	
Data input error.	Ensure correct data stream.
Incorrect label sensor selection.	Ensure correct printer configuration.
Disconnected print head.	Power off the printer and ensure a proper connection.
Defective print head.	Replace print head as required.
Defective main circuit board.	Replace main board as required.
INCORRECT LABEL POSITIONING.	
Incorrect label sensor selection.	Ensure correct printer configuration.
Improper sensor adjustment.	Adjust sensor sensitivity as required.
Data input error.	Ensure correct data stream.
Incorrect offset settings.	Adjust settings as required.
Incorrect applicator setup.	Refer to applicator documentation or contact manufacturer.
SMEARED PRINT IMAGES	
Poor media quality.	Use higher quality media.
Foreign material on print head and platen roller.	Clean print head and rollers.
Foreign material on labels.	Use higher quality media.
Excessive print head energy.	Adjust darkness setting.
Excessive print speed.	Adjust print speed as required.

INTERFACE TROUBLESHOOTING

This chapter provides a checklist for the various interface types. Locate the checklist relative to the interface used and perform each of the troubleshooting tasks until the problem has been isolated.

PARALLEL INTERFACE

PARALLEL INTERFACE	
CHK	TROUBLESHOOTING STEP
	Ensure the interface module is correctly installed. Run self-test to verify.
	Ensure the printer cable is connected to the appropriate LPT port on the host computer. If using a Windows printer driver, ensure the correct port is selected.
	Ensure a IEEE1284 printer cable is being used.
	Ensure the host's peripheral settings are set to ECP for faster throughput. Refer to the computer manufacturer's documentation for details.
	Ensure the printer is receiving information from the computer using the Receive Buffer Hex Dump mode. Refer to that procedure, in Printer Configuration, in this manual for instructions. The command stream should be continuous and possess 0Dhex and/or 0Ahex (carriage return and line feed) characters throughout. However, there should not be either located between the start (<ESC>A and the stop (<ESC>Z) commands.
	Replace the interface board with another to isolate the problem.
	Replace the interface board permanently if determined to be the problem.

RS232 SERIAL INTERFACE

RS232 SERIAL INTERFACE	
CHK	TROUBLESHOOTING STEP
	Ensure the correct interface module is correctly installed. Run self-test to verify.
	Ensure the serial cable (Null Modem) meets specifications and is correctly connected at each end.
	Ensure the serial cable is not defective.
	Ensure the communication parameters for the baud rate, parity, data bits and stop bits are consistent with those being sent from the host computer.
	Ensure the printer is receiving information from the computer using the Receive Buffer Hex Dump mode. Refer to that procedure, in Printer Configuration, in this manual for instructions. The command stream should be continuous and possess 0Dhex and/or 0Ahex (carriage return and line feed) characters throughout. However, there should not be either located between the start (<ESC>A and the stop (<ESC>Z) commands.
	Replace the interface board with another to isolate the problem.
	Replace the interface board permanently if determined to be the problem.

UNIVERSAL SERIAL BUS (USB) INTERFACE

UNIVERSAL SERIAL BUS (USB) INTERFACE	
If nothing prints during a test print, verify the device drivers have been successively installed by performing the following:	
	Click on Start, Settings, and then Control Panel.
	Click on System within the new window.

Unit 5: Troubleshooting

	Click on the Device Manager tab.
	Ensure that the View Device By Type is checked.
	Scroll to SATO-USB Device and ensure that errors do not exist. Reinstall as required.
	Reboot the PC and the printer.
	Contact Microsoft technical support for further assistance as required.

LAN ETHERNET INTERFACE

LAN ETHERNET INTERFACE	
CHK	TROUBLESHOOTING STEP
	Ensure the interface has been correctly configured. Wait two minutes and run self-test to verify. If a test label does not print, there may be a hardware problem.
	Ensure the cable and its ports are not defective.
	Ensure that a faulty print server or other protocol related scenarios are not creating a queue setup issue. Systematically perform checks and tests to isolate the cause.
	If using TCP/IP, ensure a valid IP address is specified and that all parameters are correct (subnet mask, gateway, etc.). Attempt to PING the IP address assigned to the network interface.
	If using a repeater or hub, ensure the SQE is turned off. Also ensure the repeater port is not defective by trying the print server on another port.
	Install the IPX/SPX protocol on a workstation to determine if the network device can be discovered via the MAC address. If able, configure the appropriate protocols and retest connectivity.
	Use a crossover cable to isolate the printer from the network by connecting from the interface and workstation. Verify that the parameters match on each. Test connectivity.

WIRELESS LAN INTERFACE

WIRELESS LAN INTERFACE	
CHK	TROUBLESHOOTING STEP
	Ensure the interface module is correctly installed. Run self-test to verify.
	Check the signal strength by the three LED's on the interface. The more LED's are illuminated green, the stronger the signal.
	Ensure the printer is receiving information from the computer using the Receive Buffer Hex Dump mode. Refer to that procedure, in Printer Configuration, in this manual for instructions. The command stream should be continuous and possess 0Dhex and/or 0Ahex (carriage return and line feed) characters throughout. However, there should not be either located between the start (<ESC>A and the stop (<ESC>Z) commands.
	Ensure the interface has been correctly configured. Wait two minutes and run self-test to verify. If a test label does not print, there may be a hardware problem.
	If using TCP/IP, ensure a valid IP address is specified and that all parameters are correct (subnet mask, gateway, etc.). Attempt to PING the IP address assigned to the network interface. Also ensure the SSID, channel, and security matches that of the network.
	Install the IPX/SPX protocol on a workstation to determine if the network device can be discovered via the MAC address. If able, configure the appropriate protocols and retest connectivity.
	Replace the interface board with another to isolate the problem.

	Replace the interface board permanently if determined to be the problem. Also reset the interface card.
--	---

CENTRONICS INTERFACE

CENTRONICS INTERFACE	
CHK	TROUBLESHOOTING STEP
	Ensure the interface module is correctly installed. Run self-test to verify.
	Ensure the printer cable is connected to the appropriate LPT port on the host computer. If using a Windows printer driver, ensure the correct port is selected.
	Ensure the host's peripheral settings are set for Centronics output for faster throughput. Refer to the computer manufacturer's documentation for details.
	Ensure the printer is receiving information from the computer using the Receive Buffer Hex Dump mode. Refer to that procedure, in Printer Configuration, in this manual for instructions. The command stream should be continuous and possess 0Dhex and/or 0Ahex (carriage return and line feed) characters throughout. However, there should not be either located between the start (<ESC>A and the stop (<ESC>Z) commands.
	Replace the interface board with another to isolate the problem - permanently replace if defective.

TEST PRINT TROUBLESHOOTING

Chapter provides instruction on special printing to identify and resolve specific print problems.

HEX DUMP Allows the operator to determine if there were problems in the downloading of data.

TEST LABEL Allows the operator to identify specific problems regarding mechanical performance and setup.

HEX DUMP MODE

The contents of the print buffer can be examined using the Hex Dump Mode. In the left column, each line of data received is numbered. The center column provides the data in hexadecimal format. And in the right column, same data is provided in the ASC II format. Follow the flow chart provided below to perform this activity.

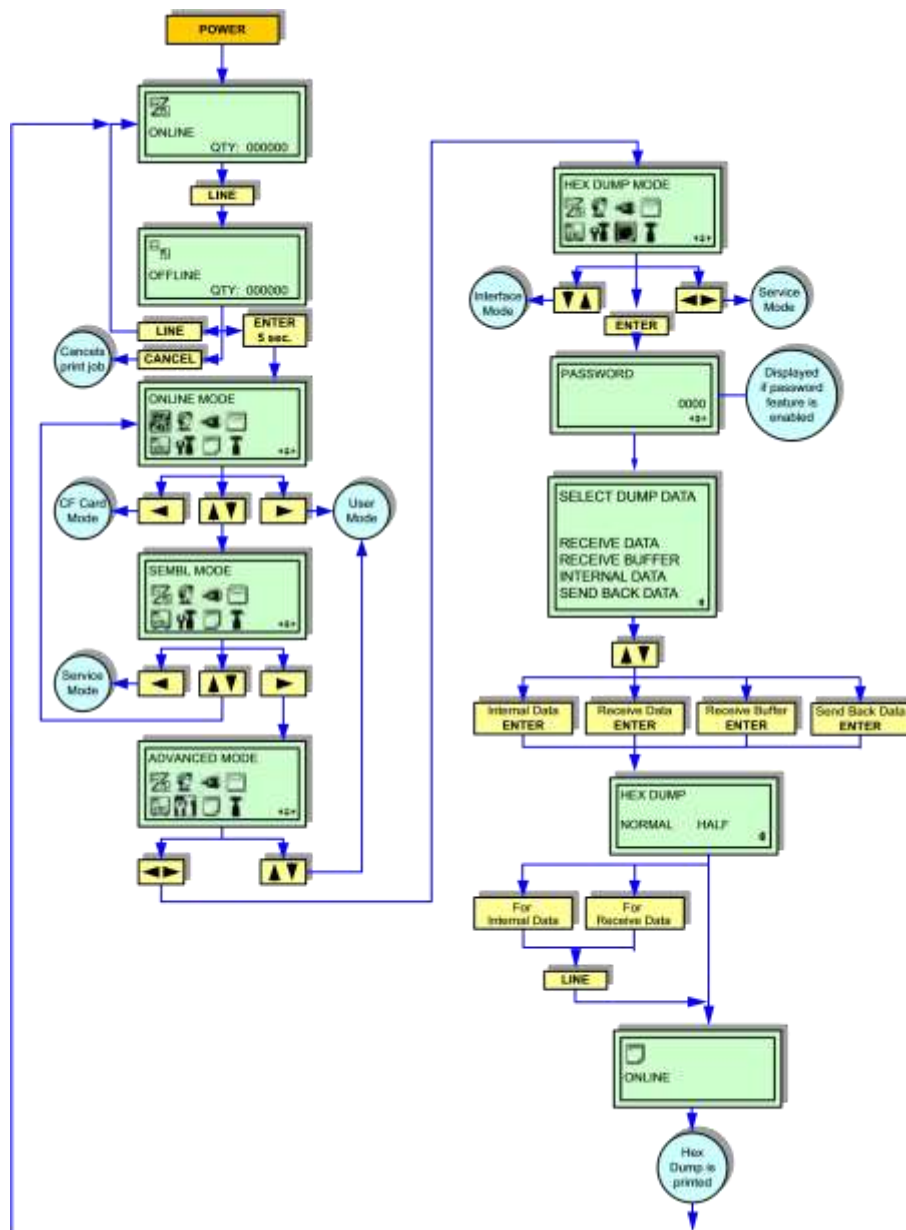

Figure 5-1, Hex Dump Mode

TEST LABEL PRINTING

The test label is designed to assist in the identification of print problems. Follow the flow chart provided below to perform this activity.

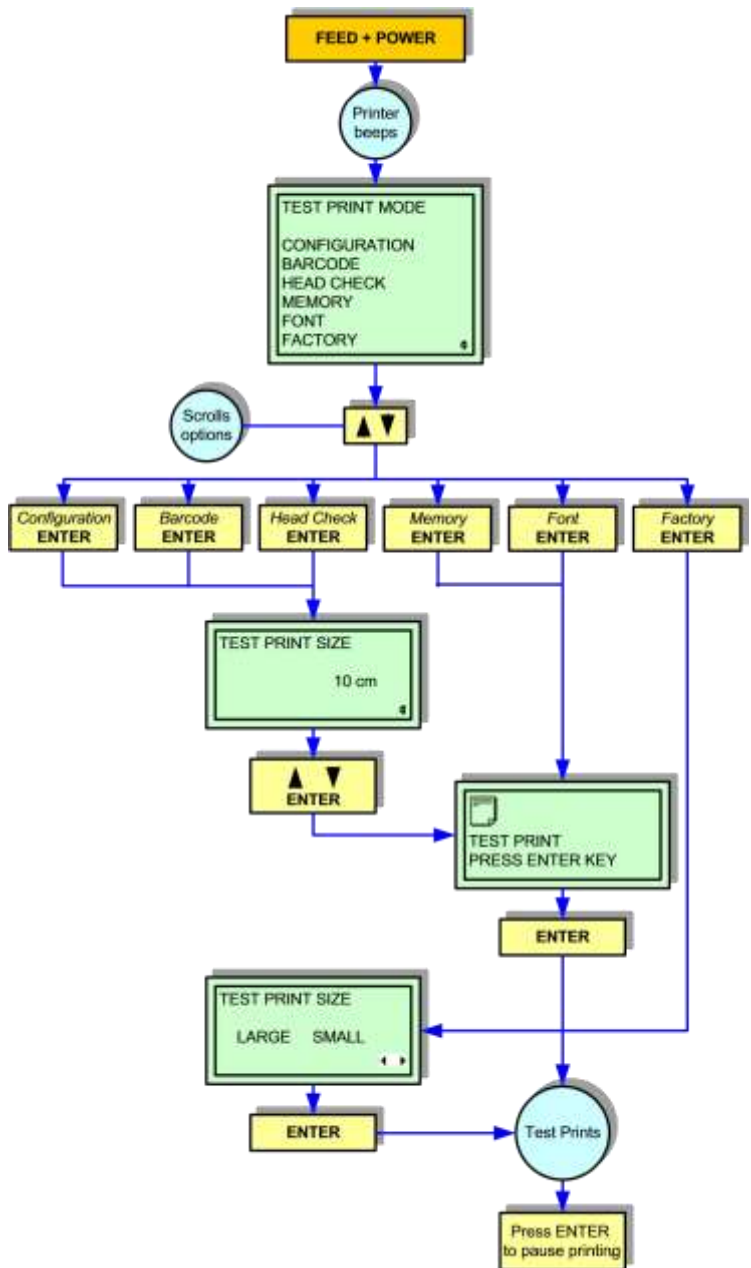

Figure 5-2, Test Print Mode

SAMPLE TEST LABEL

NOTE: The only print problem that the following sample test label does not display is fading of print image from one side of the label to the other. This is the result of improper print head balance.

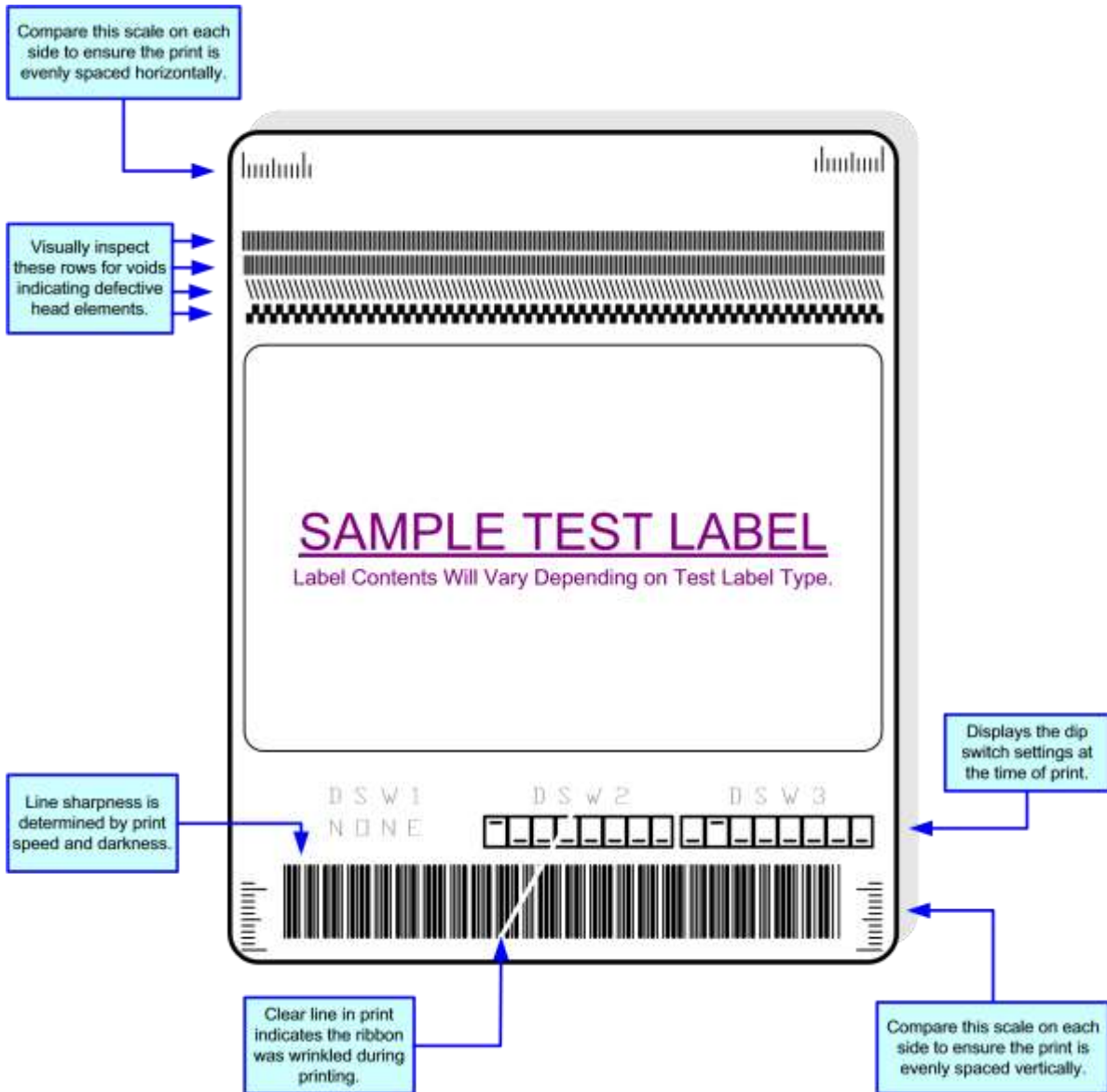

Figure 5-3, Sample Test Label

This page is intentionally left blank.

6

MAINTENANCE

- **Cleaning Procedures**
- **Replacement Procedures**
- **Adjustment Procedures**

MAINTENANCE

CLEANING PROCEDURES

Cleaning of the printer is a necessary maintenance activity to ensure print quality and longer printer life. There are two basic types of cleaning involved; the removal of loose debris and the removal of residue.

Use a soft cloth and/or a pneumatic blower to remove debris from the printer. This process should be performed prior to the removal of residue. To remove residue, apply SATO Solvent or isopropyl alcohol 90%+ to a clean lintfree cloth, and gently wipe the entire surface of the print head and rollers until clean.

To gain access to the pressure roller assembly, pull purple knob (1) upward to drop plate downward. Remove thumbscrew (2), should removal of the plate (3) become necessary.

Clean print head at the following intervals: For thermal transfer, clean at every change of ribbon. For direct thermal, clean at every change of label roll.

WARNING: DISCONNECT POWER SUPPLY TO THE PRINTER AND ALLOW TO COOL TO ROOM TEMPERATURE PRIOR TO CLEANING. EXERCISE CARE WHEN CLEANING TO PREVENT PERSONAL INJURY.

CAUTION: IF USING A PNEUMATIC BLOWER TO REMOVE DEBRIS FROM THE PRINTER, EXERCISE CARE TO PREVENT PRINT HEAD DAMAGE.

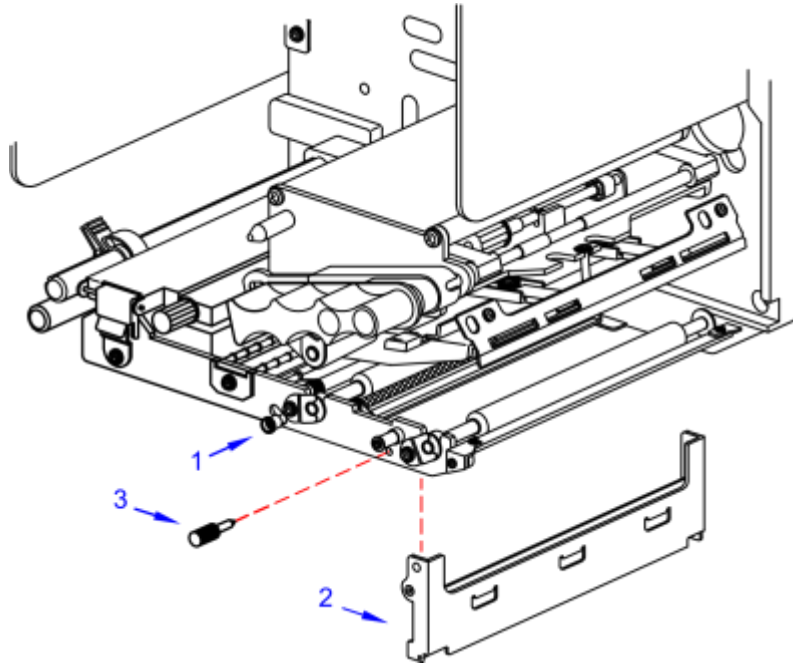

Figure 6-1, Printer Cleaning

REPLACEMENT PROCEDURES

This unit provides in-depth instruction on all primary component and assembly replacement, in addition to most secondary components. Use the text in conjunction with their accompanied graphics to ensure complete comprehension throughout the process. Especially observe all cautionary or warning notations.

CAUTION: STATIC ELECTRICITY CAN RESULT IN COMPONENT DAMAGE. OBSERVE APPROPRIATE GROUNDING PROCEDURES WHEN REPLACING ANY COMPONENTS.

PRINT HEAD REPLACEMENT

If the print head becomes damaged or worn, it can be easily removed and replaced without having to make critical adjustments. Before replacing the print head, check the head counter values by printing a test pattern. Instructions relating to the Head Counter may be found in the Configuration unit of this manual.

1. Switch off the printer and observe applicable lockout-tagout procedures.
2. Disengage print head latch (1, Figure 6-2) and remove ribbon stock as necessary.
3. Pull outward on print head release knob (2) to release defective print head (3) from print assembly.
4. Disconnect the two wiring harnesses (not shown) from defective print head (3).
5. Reconnect two wiring harnesses (not shown) to replacement print head (3).

NOTE: Each of the printer's wiring harness connectors are different from all others to ensure proper mating. Mate each matching half for reconnection.

6. Insert replacement print head (3) into print assembly (4) and press upward into position until latched.

CAUTION: EXERCISE CARE WHEN INSTALLING THE PRINT HEAD TO ENSURE THAT ITS ELEMENTS ARE NOT DAMAGED DURING INSTALLATION.

7. Restore power, reload the printer, reset the head counter, and test print to ensure proper function.

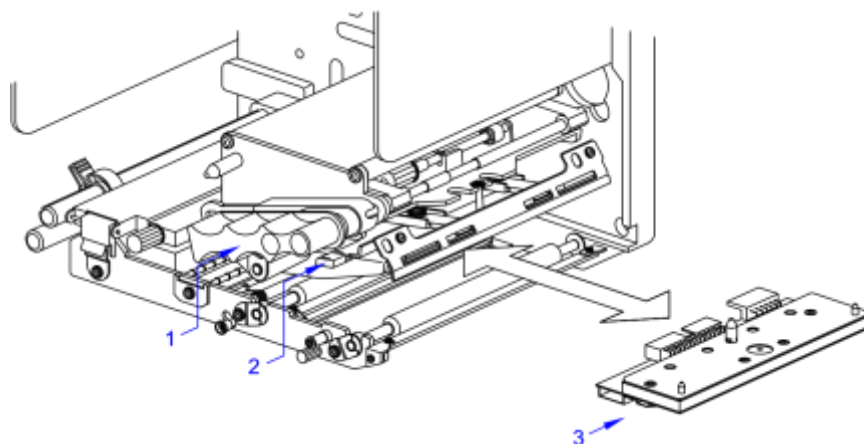

Figure 6-2, Print Head Replacement

PLATEN ROLLER REPLACEMENT

The printer's platen roller is considered to be a high-wear component due to constant treading of the print media and ribbon stock against its contact surface. This constant contact will eventually wear grooves into the rubber material and negatively affect print output. This procedure applies to all three rubber rollers.

1. Switch off the printer and observe appropriate lockout-tagout procedures.
2. Remove label media as required.
3. Loosen screw (1, Figure 6-3) sufficiently to rotate bearing clamp (2) from bearing (3).

NOTE: Figure 6-3 shows screw (1) and bearing clamp (2) as being removed for display purposes only. It is not necessary to remove those components for roller replacement.

4. Withdraw bearing (3) from chassis (4) and worn roller (5).
5. Withdraw worn roller (5) from the printer and insert replacement roller (5) in its place.
6. Insert bearing (3) onto the free end of replacement roller (5) to nest against chassis (4).
7. Rotate bearing clamp (2) onto bearing (3) and secure screw (1).

NOTE: Ensure the platen roller assembly is fully nested in the printer's center frame when screw (1) is secured.

8. Repeat steps 3 through 8 as required for other rollers, and restore power.

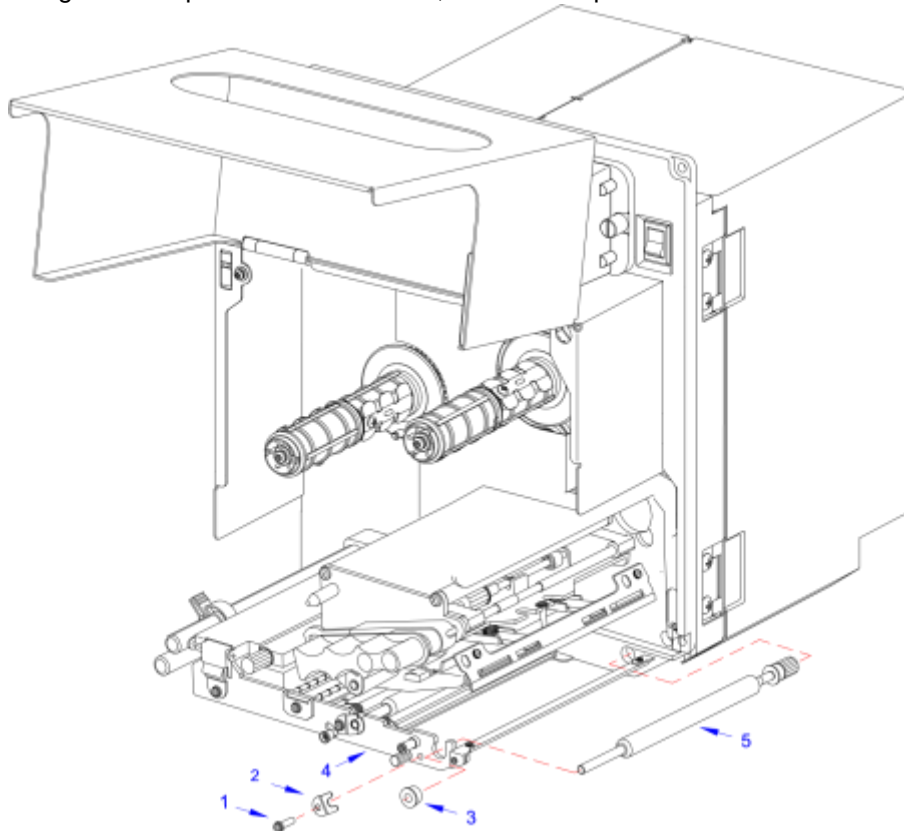

Figure 6-3, Platen Roller Replacement

INTERFACE BOARD REPLACEMENT

Circuit boards generally have long lives due to the lack of moving parts. Generally, if a circuit board becomes defective, it contributes to a negative external condition.

If it is determined that the circuit board has become defective, search the printer over for possible visual factors that may have led to the damage.

1. Switch off the printer and observe applicable lockout-tagout procedures.
2. Disconnect interface cable (1, Figure 6-4) from defective interface board (2).
3. Remove two screws (3) securing defective interface board (2) to printer (4).
4. Insert replacement interface board (2) into printer (4) and secure using two screws (3).
5. Connect interface cable (1).

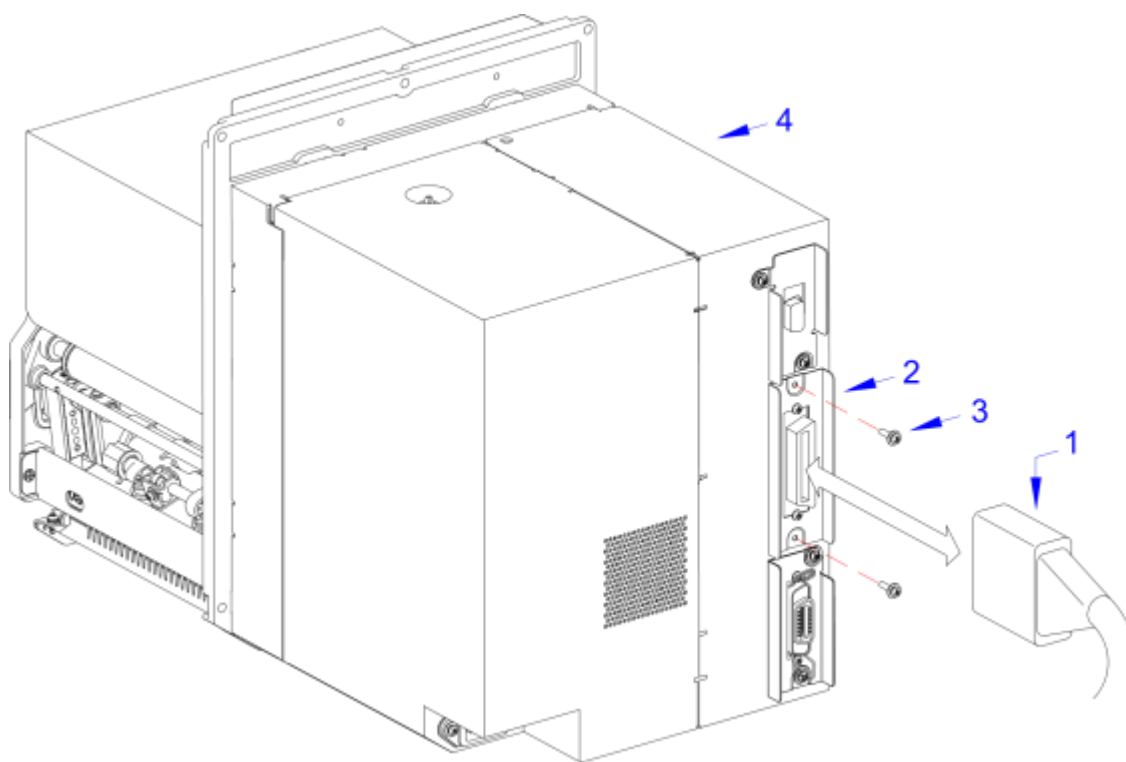

Figure 6-4, Interface Board Replacement

FAN FILTER REPLACEMENT

The fan filter prevents atmospheric debris from being drawn into the printer adversely affecting component performance. The filter is adhesive on the contact side. To install, simply remove the contaminated filter, peel away the adhesive paper backing, and apply over the fan exhaust holes. Refer to Figure 6-5 for guidance.

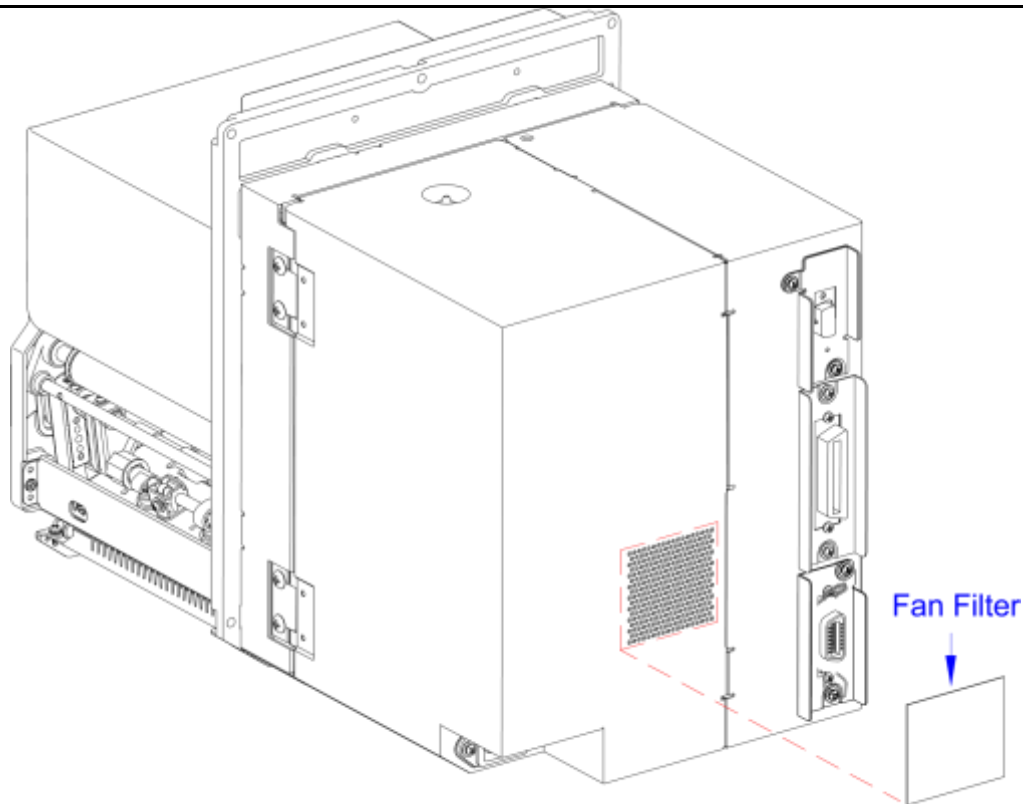

Figure 6-5, Fan Filter Replacement

ADJUSTMENT PROCEDURES

This unit covers all of the printer and printer accessory adjustments. These adjustments include mechanical adjustments required following the replacement of components and assemblies, in addition to, the operational adjustments required following a job change.

LABEL SENSOR POSITIONING

The label sensor assembly provides a mounting apparatus for the I-mark, gap, and paper-end sensors. The position adjustment for standard label media is 0mm (the inner most position). Zero (0mm) is the default setting. When non-standard media is used, the label sensor must be adjusted to align with media's reference mark. The adjustment range for I-mark sensor usage is 45.0 to 65.5mm, and the gap sensor adjustment range is 5.0 to 66mm. The sensor adjustment scale is in 5mm increments.

1. Open the front housing cover to access print assembly (1, Figure 6-6).
2. Lift upward on print head latch (2) to disengage the print head as required.
3. Lift upward on label sensor latch (3) to hinge open the upper half of label sensor assembly (4).
4. Place label media (5) face-up and laterally onto printer chassis (6). Re latch label sensor assembly (4).
5. Find label sensor adjustment knob (7) located behind print assembly (1).

NOTE: The label sensor adjustment knob is purple colored ABS plastic.

6. Manually rotate knob (7) to the left or right as required to properly position label sensor (8).

NOTE: Sensor positioning may also be achieved by measuring from the printer's center frame outward to the specified distance for sensor/reference mark alignment.

7. Test print a label to determine if label sensor (8) is properly aligned.

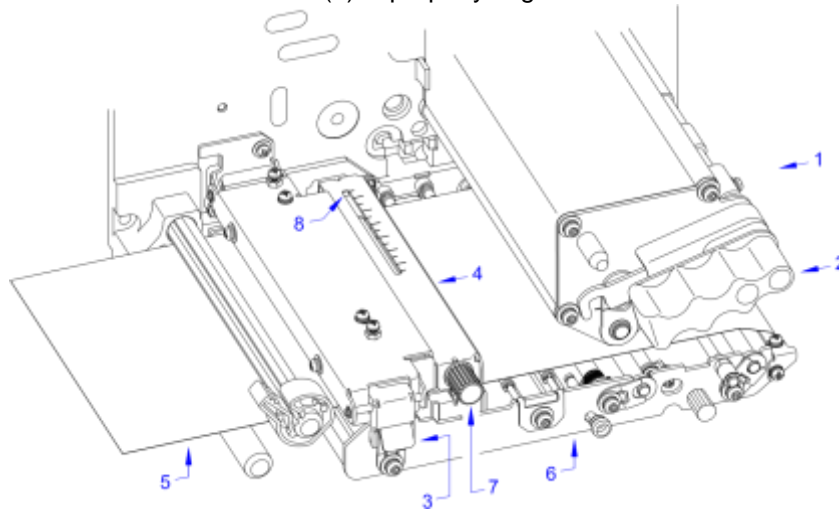

Figure 6-6, Label Sensor Positioning

ADJUSTMENT OF HEAD POSITION

Side or Left - Right pressure balance

1. Lock the thermal head assembly into position. Locate adjust collar, indicated by arrow in Figure 6-7.
2. Loosen the screw indicated in Figure 6-8 with Phillips screwdriver. Do not completely unscrew.
3. Rotate the adjust collar to adjust the head pressure balance.
 Left hand turn → Increasing head pressure on the frame side.
 Right hand turn → Increasing head pressure on the opposite of the frame side.
4. Tighten the screw that you previously loosened in step 2. Hold the adjust-collar when you tighten the screw.

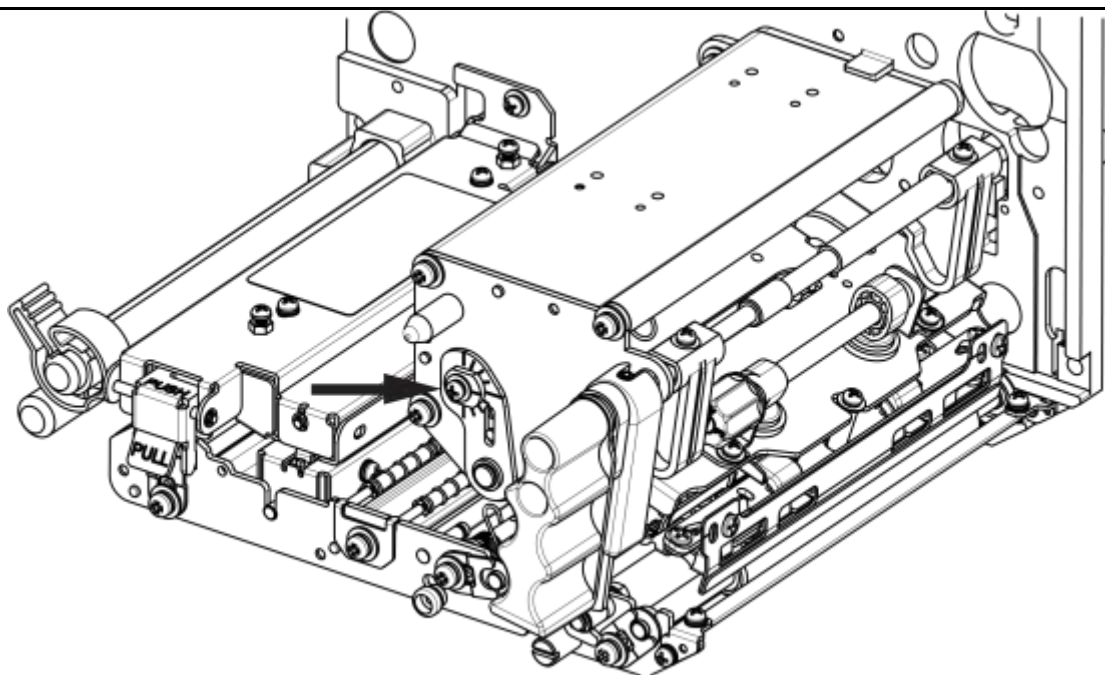

Figure 6-7, Print Head Adjustment, Adjust Collar

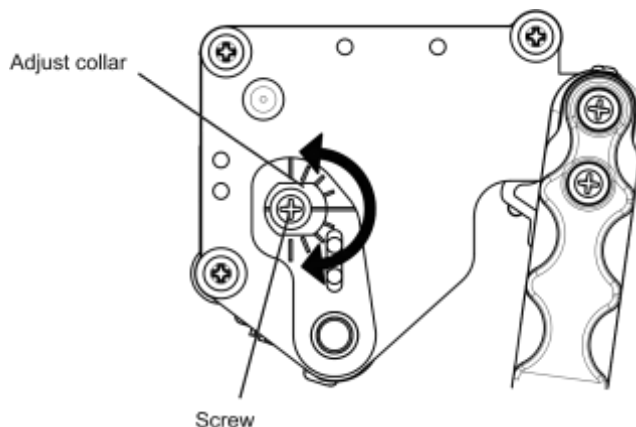

Figure 6-8, Print Head Adjustment

ADJUSTMENT OF HEAD POSITION, (Cont'd)

Front - Rear pressure balance (longitudinal position, forward and backward/alignment)

1. Lock the print head in position. Locate the area represented in the figures below.
2. Loosen the screws indicated in Figure 6-10 with Phillips screwdriver. Do not completely unscrew.
3. Insert slotted screwdriver into the holes on the left and the right sides and adjust the head position by turning the screwdriver in the relevant direction.
 Direction A: Head position moves forward.
 Direction B: Head position moves backward.
4. Tighten the screw loosened in Step 2.

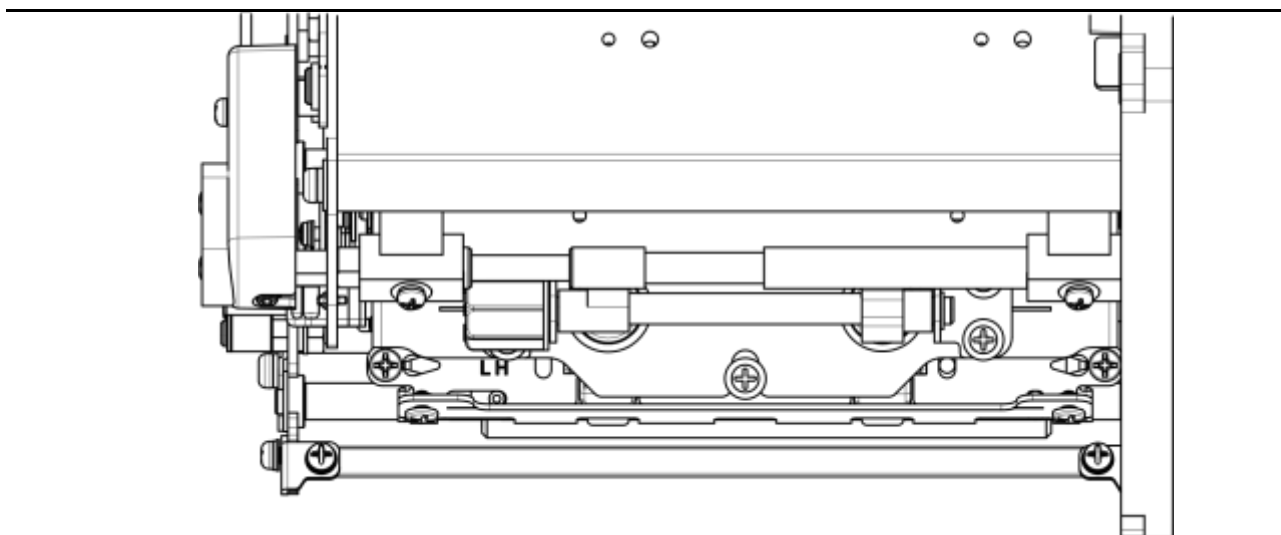

Figure 6-9, Print Head Adjustment, Front - Rear Balance

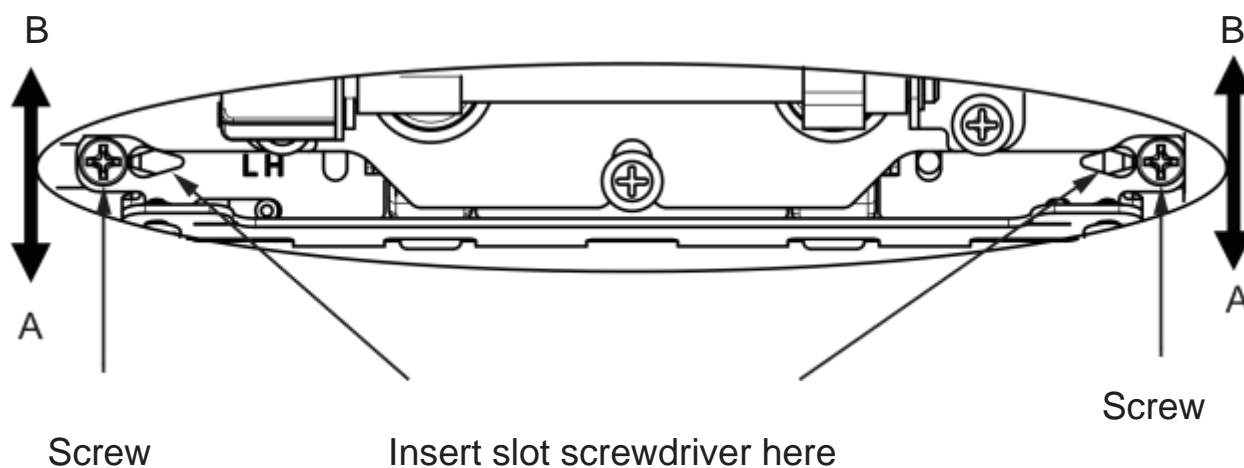

Figure 6-10, Print Head Adjustment, Enlargement of Portion of Figure 6-9

SETTING HEAD PRESSURE AND BALANCE

Print head balance is the equalization of pressure against the platen roller from one end to the opposite end. If the print head balance is out of adjustment, the printed image will be darker on one side of the label than on the other side, and the media will be prone to travel in the direction of least resistance.

The adjustment of print head balance on the label can be subjective. One will know when balance is achieved by the disappearance of prevailing negative characteristics.

Adjust head pressure balance depending on the media (label) to be used.

Adjust head pressure according to the media thickness to be used. Include backing liner in overall thickness when using labels.

If the dial is too difficult to manually adjust using fingertips, a slotted screwdriver may be inserted into its end for easier dial rotation.

Pressure balance setting (2-parameter adjustment)

The factory default is 2. Refer to Figure 6-11. The embossed number on the dial's end that is positioned closest to the print head is the setting that is in effect.

1. Tune the head balance dial for adjustment to the media width. For adjusting to the relevant media width, refer to the table below.

Media width (mm)	30-128	10-(not including liner)30	30-128	10-(not including liner)30
Balance scale	1	3	2	4

2. Tune the head balance dial for adjustment to the media thickness. To adjust to the relevant thickness, refer to the table below.

Media thickness (mm)	0.05-0.20	0.20-0.31
Balance scale	1 or 3	2 or 4
Note	Thin paper, label	Thick paper, tag

In the above table, the label thickness includes the thickness of backing liner.

In order to tune balance, insert the slotted screwdriver into the slot of the dial.

After this adjustment, if some print problems persist, the print head alignment may require adjustment. Following print head alignment, the print head balance may require a different setting and the procedure repeated.

SETTING HEAD PRESSURE AND BALANCE, (Cont'd)

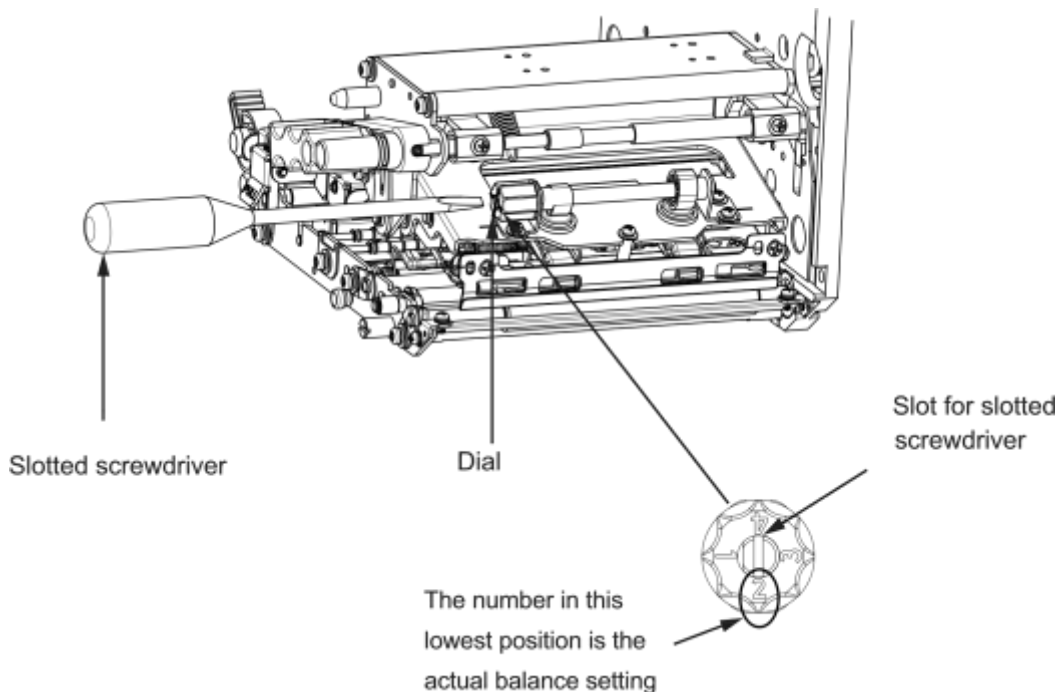

Figure 6-11, Print Head, Adjusting Head Pressure and Balance

RIBBON GUIDE ALIGNMENT

If the print ribbon is not spread smoothly over the print head when it makes contact with the media, print voids will occur at the point of the ribbon fold. Typically, this is the result of the axis of one of the following not being perfectly parallel with the platen roller: ribbon spindle, print head, or ribbon guide.

The purpose of the adjustable ribbon guide is to compensate for the axis deviations of the other two. By adjusting the ribbon guide proportionally to the degree of deviation, the ribbon spreads smoothly as it travels from the ribbon supply spindle, to the guide, and beyond.

Ribbon guide adjustment is a trial and error activity that requires the pause of printing, unlatching of the print head, adjusting the guide, re latching the print head, and printing once again. Several labels must be printed following each adjustment to determine if the adjustment was effective.

The ribbon guide is secured to the face of the print assembly by a screw on each end. Before adjusting the guide, visually inspect that its axis is parallel with that of the print assembly. If not, adjust accordingly, ensure the set screws are secure, and once again commence printing. By starting in a neutral position, either end may be adjusted vertically as necessary to remedy the wrinkling problem.

1. Test print a label to ensure the print head is properly balanced and aligned.

NOTE: Refer to their relative procedures within this manual for guidance on Print Head Balance and Print Head Alignment.

2. Disengage the print head latch.
3. Loosen one of the two set screws (1, Figure 6-12) and move the free end of ribbon guide (2) upward or downward as necessary until the ribbon appears to unwrinkle.
4. Retighten loose set screw (1) while holding ribbon guide (2) in place.
5. Engage print head latch, close cover, and test print a label.
6. Repeat steps 2 through 5 until proper alignment is achieved.

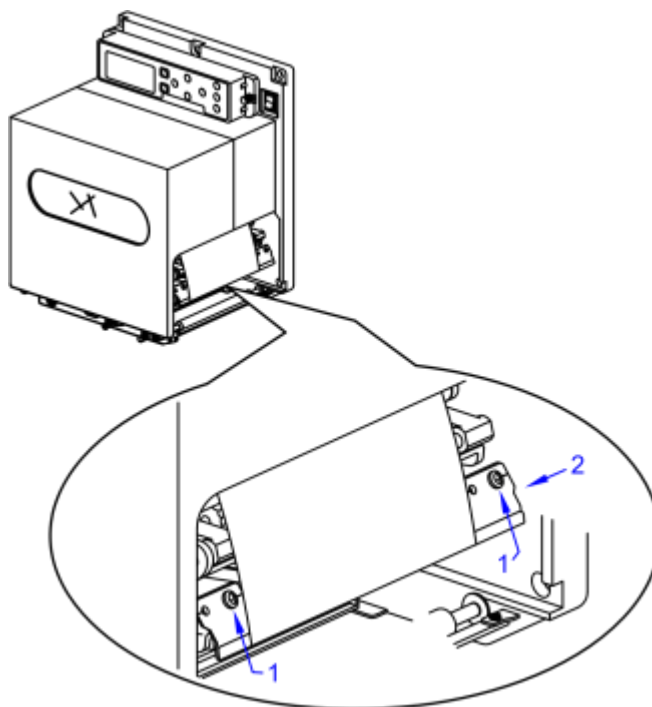

Figure 6-12, Ribbon Guide Alignment

MEDIA PRESSURE ROLLER BALANCE

Pressure roller balance adjustment may be required if the media is inclined to meander at the printer's rear to one side. When all things are properly aligned and balanced, the media will continuously feed from the printer's rear, through to its front without lateral movement creating resistance on its left or right sides.

Before adjusting the pressure rollers, ensure the media roll is harmoniously positioned and aligned so that it may flow perfectly parallel to the printer. Next, ensure the printer's print head is properly aligned and balanced. If all other conditions are confirmed to be adequate and the media's edge is still dragging against either the printer's center wall or the media guide, then adjust the pressure roller balance.

These pressure rollers are spring loaded on each end and embedded in the label sensor assembly. By adjusting the setscrew on either end downward, the pressure on that end is increased. Likewise, an adjustment of a setscrew upward on either end, reduces pressure on that side.

To adjust pressure roller balance, loosen the locknut on given side and adjust the relative setscrew to increase or decrease pressure as deemed appropriate. When the desired outcome is achieved, hold the setscrew in position while tightening its locknut.

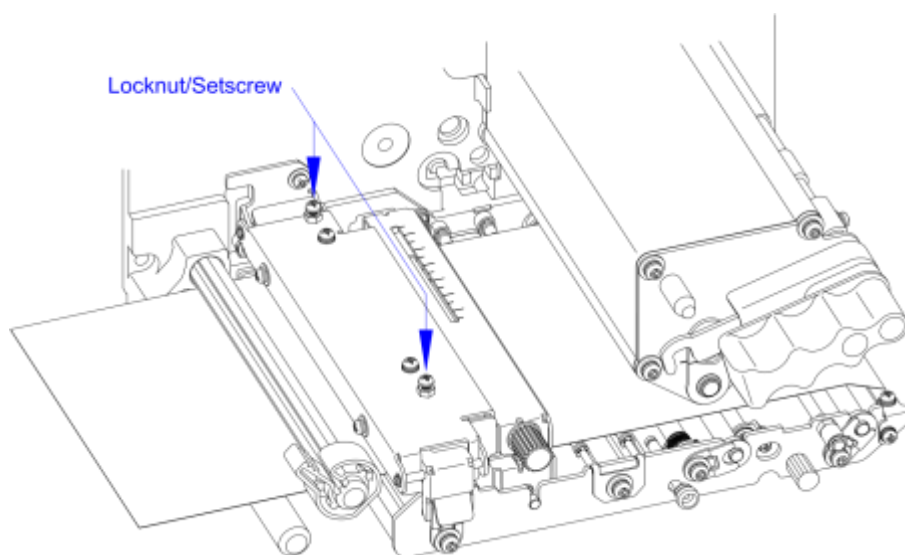

Figure 6-13, Media Pressure Roller Balance

I-MARK/PAPER-END SENSOR SENSITIVITY

This sensor adjustment regulates penetrating ability for media referencing. For proper performance, the sensor must have a voltage difference greater than 0.8V between high and low. If performing the following procedure does not result in acceptable voltage levels, clean the window over the sensor's eye.

1. Load printer with label media so the white backing paper may be registered by the I-mark sensor. Power on the printer.
2. Using the printer's operator panel, access the Service Mode and then proceed to the Level Offset menu screen (Figure 6-14).
3. Using the printer's operator panel, adjust the level offset so the sensor level reading is above 1.0V.



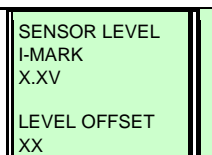

Figure 6-14, Level Offset Menu Screen

4. Manually position the media so that its I-mark may be registered by the sensor.
5. Read the sensor level now displayed to ensure this reading is below 0.5V and the high value that was previously registered is at least 0.8V greater than the low reading just read.
6. Add these readings and divide them by two. Record the result.
7. Advance to the Slice Level menu screen (Figure 6-15).

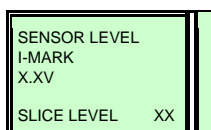

Figure 6-15, Slice Level Menu Screen

8. Read the slice level displayed to ensure the slice level is equal to this value.
9. Repeat steps 3 through 8 as required.

NOTE: When operating with “gap labels,” a Level Offset value between 10 and 15 will normally eliminate any false paper end errors.

GAP SENSOR SENSITIVITY

This sensor adjustment regulates penetrating ability for media referencing. To establish penetration, upper and lower voltage levels must be set and the difference between the two voltage levels should be maximized for optimum performance.

To force auto-calibration, set the Sensor level to 0.0V. Load label media and feed several labels. If labels do not register properly, perform the manual calibration.

In most cases, the printer will auto-calibrate to the loaded label stock after closing the print head and feeding a label. The following manual procedure can be performed when labels are not able to register properly after autocalibrating.

For proper performance, the sensor must have a voltage difference greater than 0.8V between high and low. If performing the following procedure does not result in acceptable voltage levels, clean the window over the sensor's eye with a clean, dry cloth.

1. Load printer with liner only under the label sensor. Power on the printer.
2. Using the printer's operator panel, access the Service Mode and then proceed to the Level Offset menu screen (Figure 6-16).
3. Using the printer's operator panel, adjust the level offset so that the sensor level is between 0.3V and 0.5V.

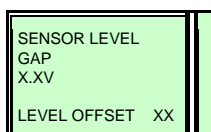

Figure 6-16, Level Offset Menu Screen

4. Place label media (liner and label) under the sensor.
5. Read the sensor level now displayed to ensure that this reading is at least 0.8V greater than the low reading from Step 3.
6. Add these readings (low value + high value), and divide the sum by two. Record the result.
7. Advance to the Slice Level menu screen (Figure 6-17).

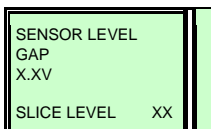

Figure 6-17, Slice Level Menu Screen

8. Adjust the slice level displayed equal to the value recorded in Step 6.
9. Repeat steps 3 through 8 as required.

OPERATIONAL ADJUSTMENTS

These operational adjustments are for fine tuning the printer as necessary following the configuration process and are largely confined to the four potentiometers located on the operator panel. Refer to the table below for their function.

POTENTIOMETER	DESCRIPTION/PROCEDURE
PITCH	<p>Is to be used in conjunction with the configuration adjustments. Make course adjustments there and then fine tune here. If unable to achieve the desired setting here, the course adjustment must be reset. Adjust this potentiometer as labels are being printed. Allow two labels to be printed for each adjustment to ensure a desired setting.</p> <p>Adjustment of the PITCH potentiometer will affect the print offset position.</p>
OFFSET	<p>The offset adjustment is used to reposition the media for printing following advancement for dispensing. A label is printed, it is fed forward for dispense, the printer retracts the remaining media (offset) to print the next label. To perform this adjustment:</p> <ol style="list-style-type: none"> 1. Power On the printer. 2. Press the LINE key to place printer offline. 3. Advance to the User Mode and press FEED. 4. Adjust the OFFSET potentiometer. 5. Press the FEED key to feed another label. 6. Repeat steps 3 and 4 until desired offset is achieved. 7. Press the LINE key to bring the printer back online.
DARKNESS	<p>Is used to adjust the darkness or lightness of the printed image and should be used in conjunction with the configuration adjustments. Make course adjustments there and then fine tune here. If unable to achieve the desired setting here, the course adjustment must be reset.</p> <p>Adjust this potentiometer as labels are being printed. Allow two labels to be printed for each adjustment to ensure a desired setting.</p>

7

APPENDIX

- Ready/Busy Timing Charts
- X-On/X-Off Timing Charts
- Session Connect/Disconnect Diagram
- Printer Dimensions (LH Direct Load)
- Printer Dimensions (RH Direct Load)

APPENDIX

READY/BUSY TIMING CHARTS

1) Normal process

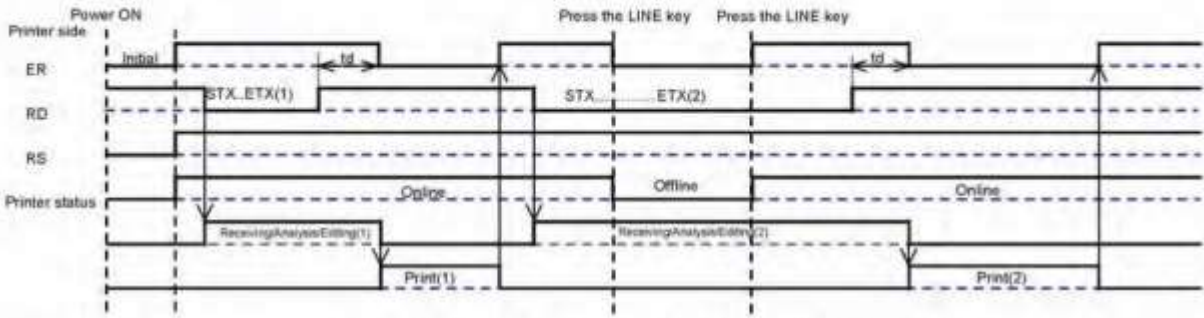

td: It takes the printer 10µs approx to recognize the end of item and to start controlling ER.

(2) Error process

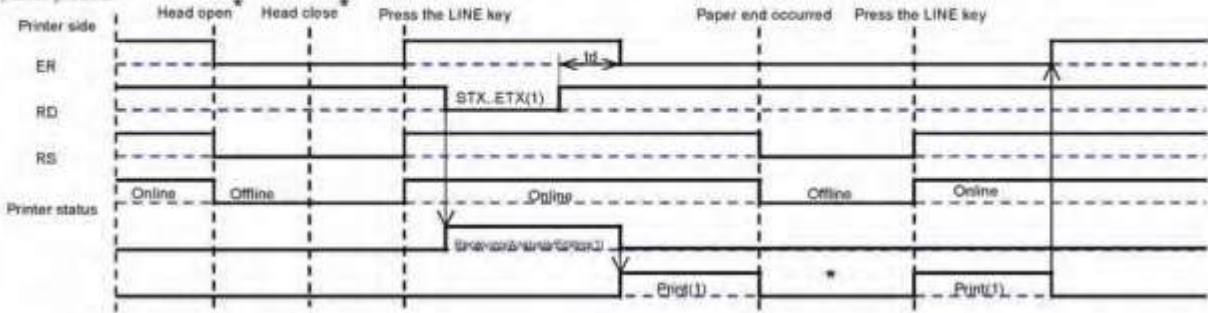
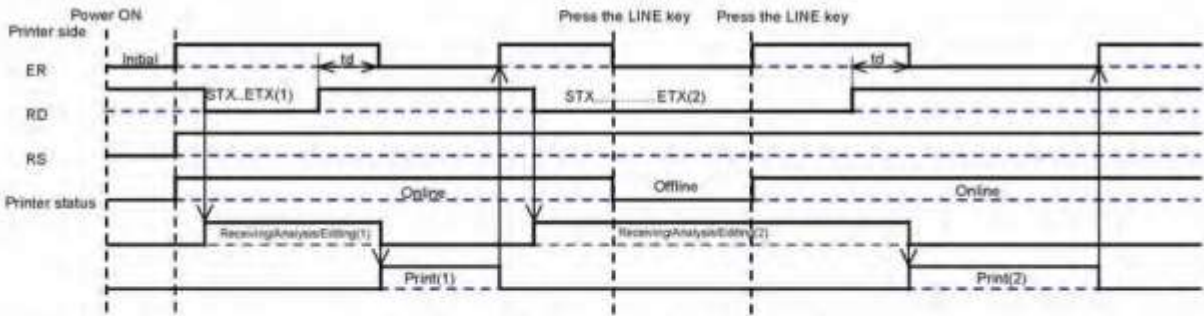

Figure 7-1a, Single-Item Buffer Timing Charts

1) Normal process



td: It takes the printer 10µs approx to recognize the end of item and to start controlling ER.

(2) Error process

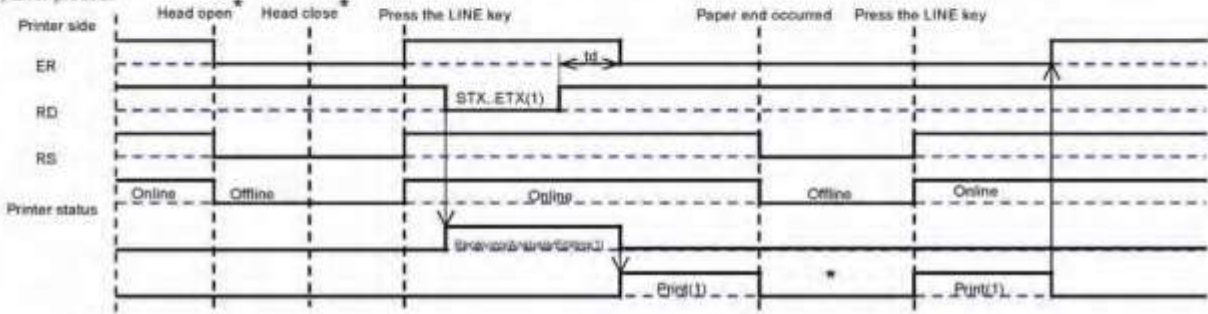

Figure 7-1b, Multiple-Item Buffer Timing Charts

X-ON/X-OFF TIMING CHARTS

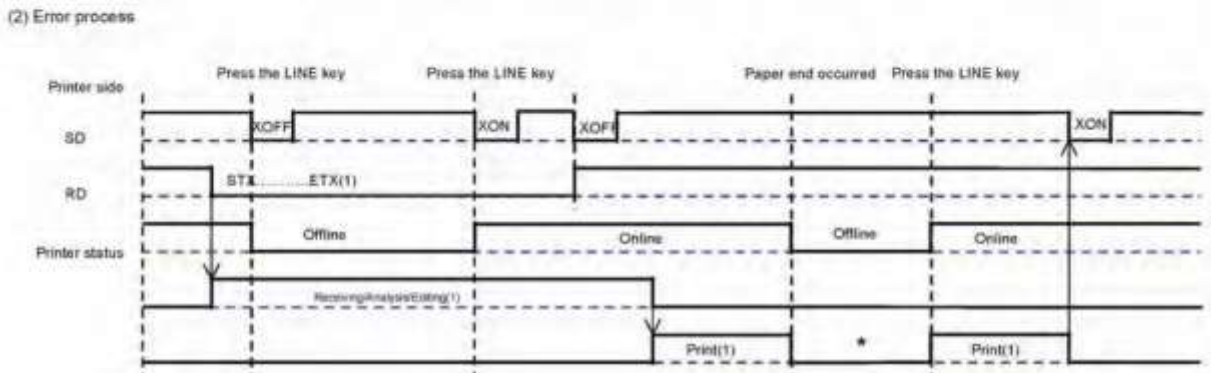
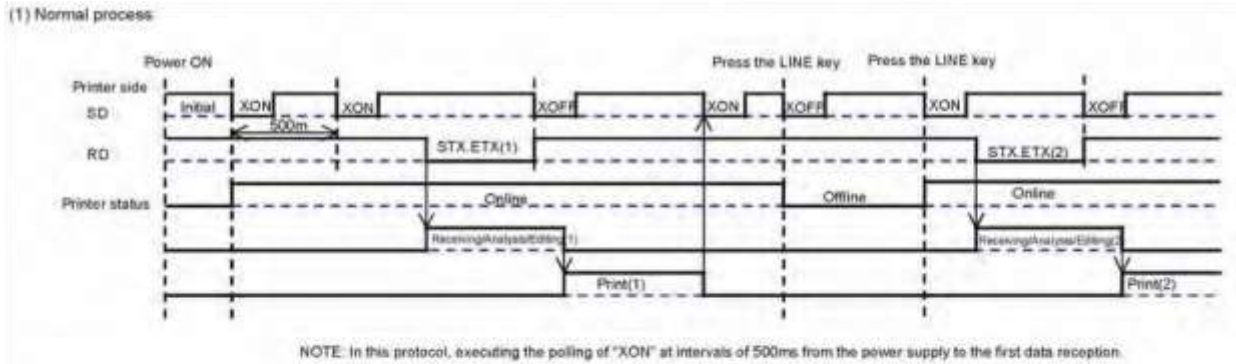

Figure 7-2a, Single-Item Buffer Timing Chart

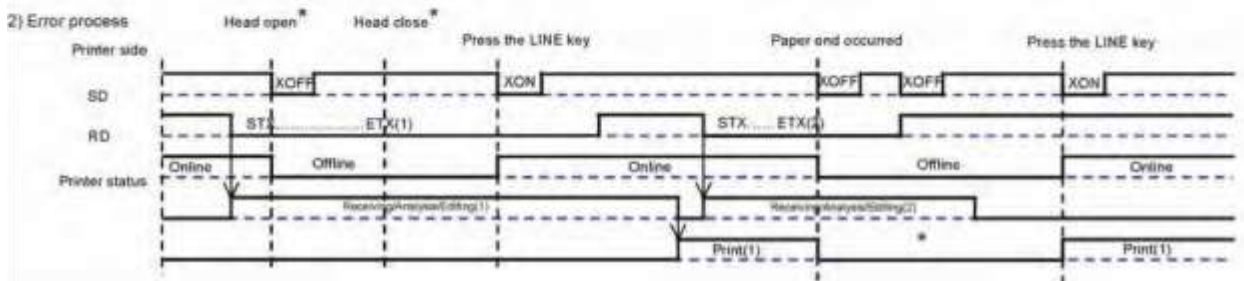
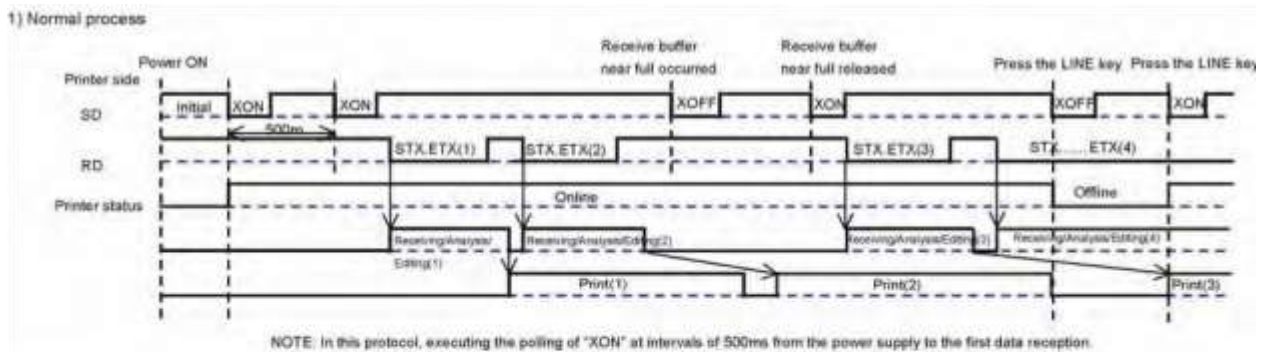

Figure 7-2b, Multiple-Item Buffer Timing Chart

SESSION CONNECT/DISCONNECT DIAGRAM

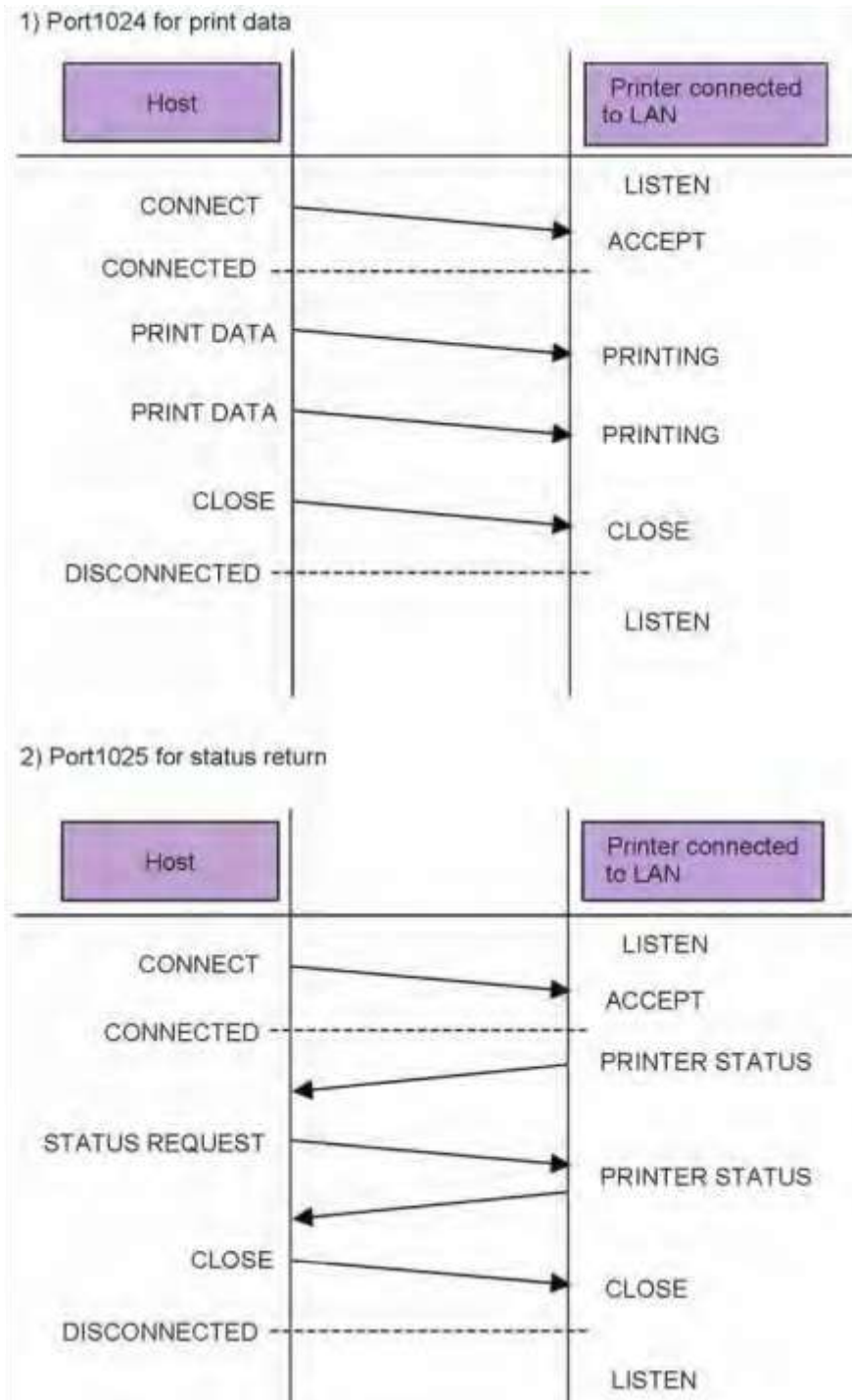

Figure 7-3, Session connect/Disconnect Diagram

PRINTER DIMENSIONS (STANDARD DIRECT LOAD)

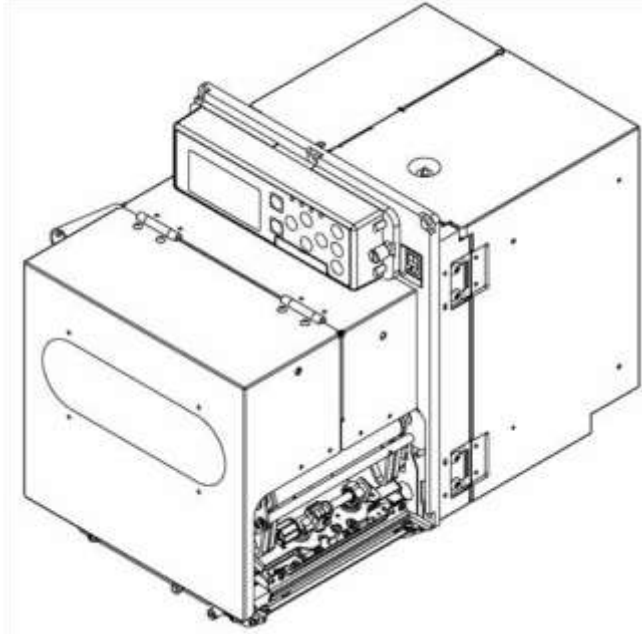

Figure 7-4a, Printer Three/Quarter View

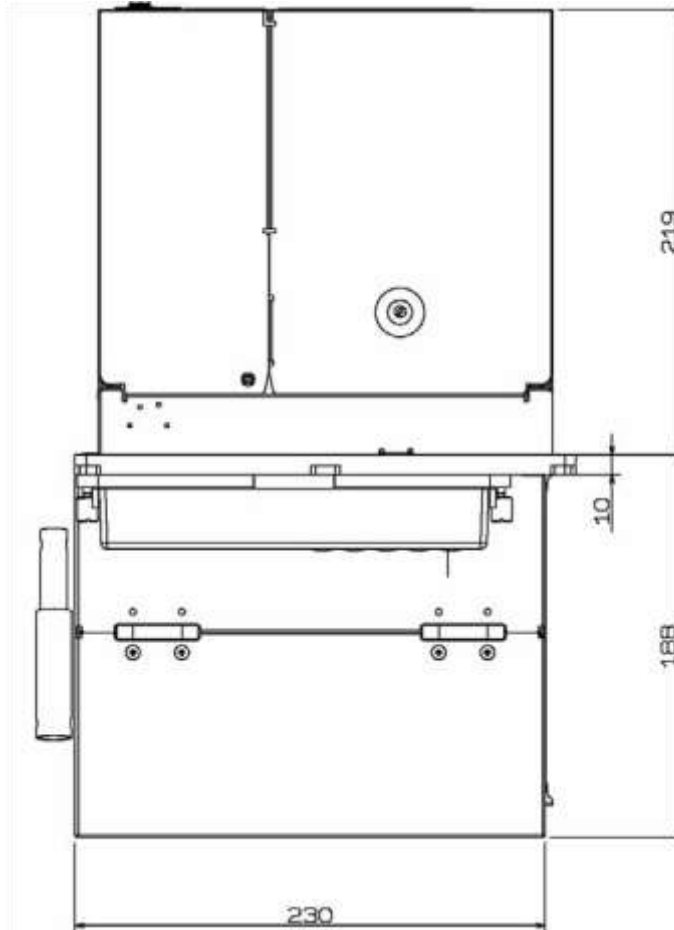

Figure 7-4b, Printer Top View

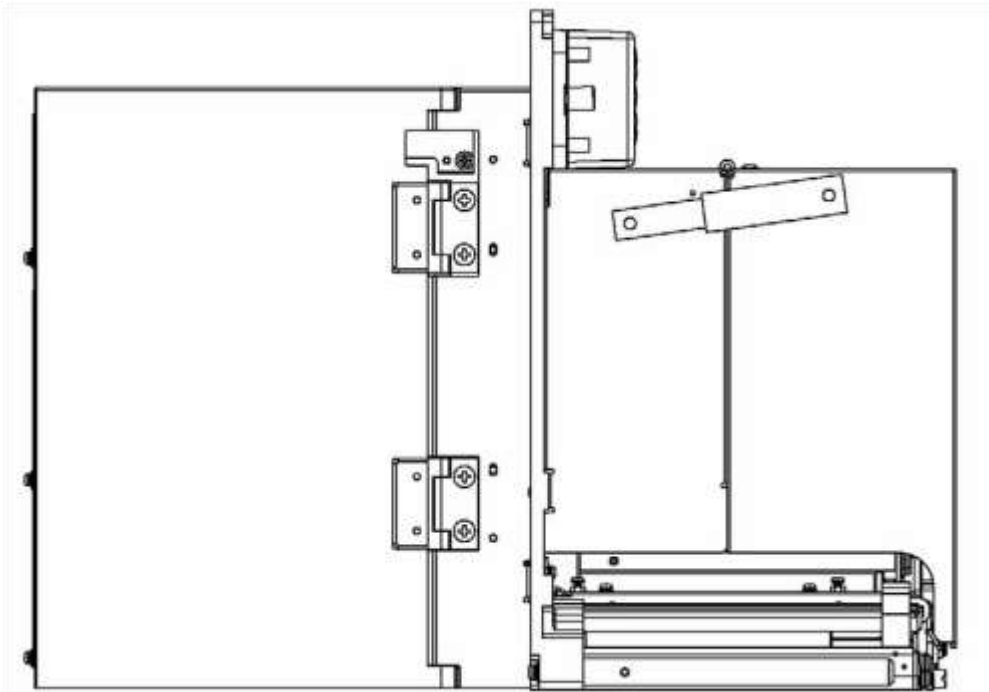

Figure 7-4c, Printer Left-Side View

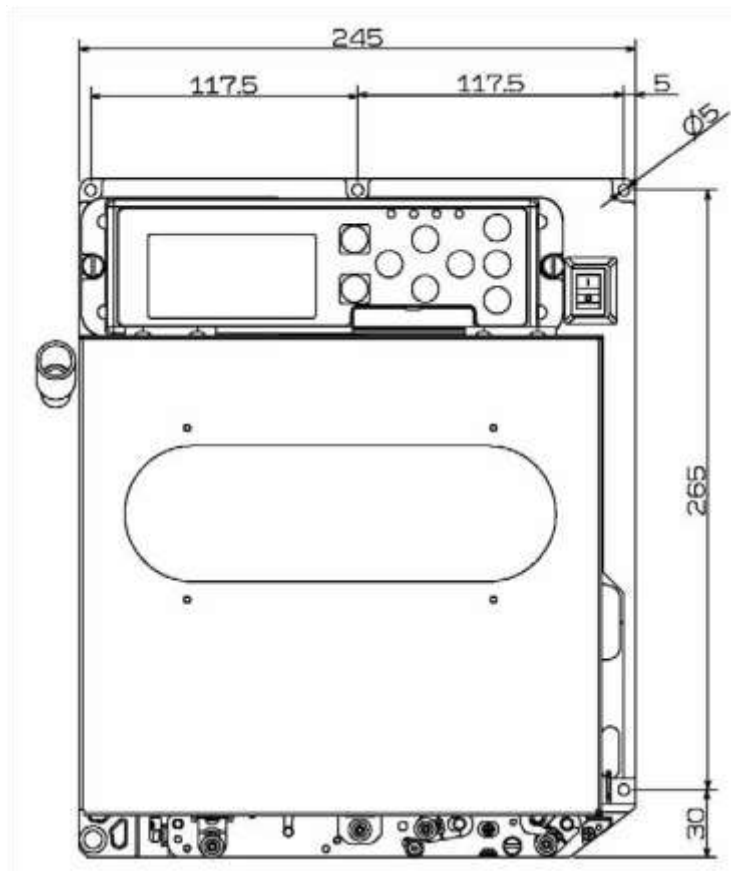

Figure 7-4d, Printer Front View

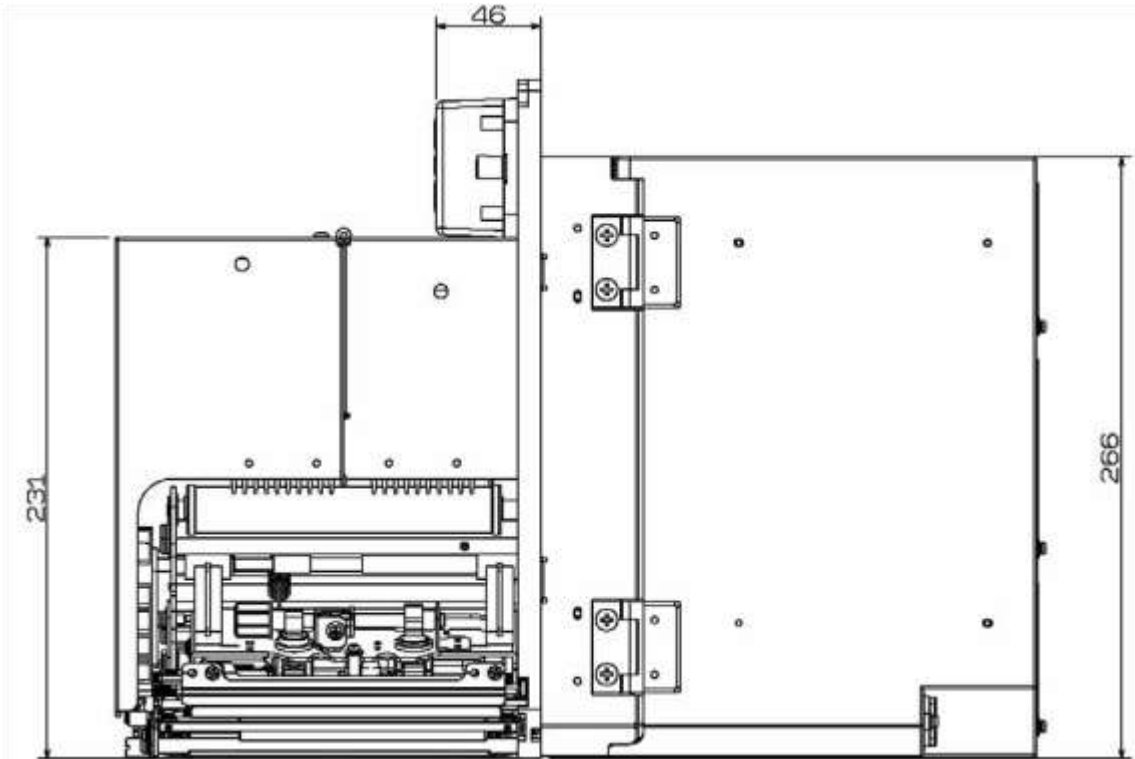

Figure 7-4e, Printer Right-Side View

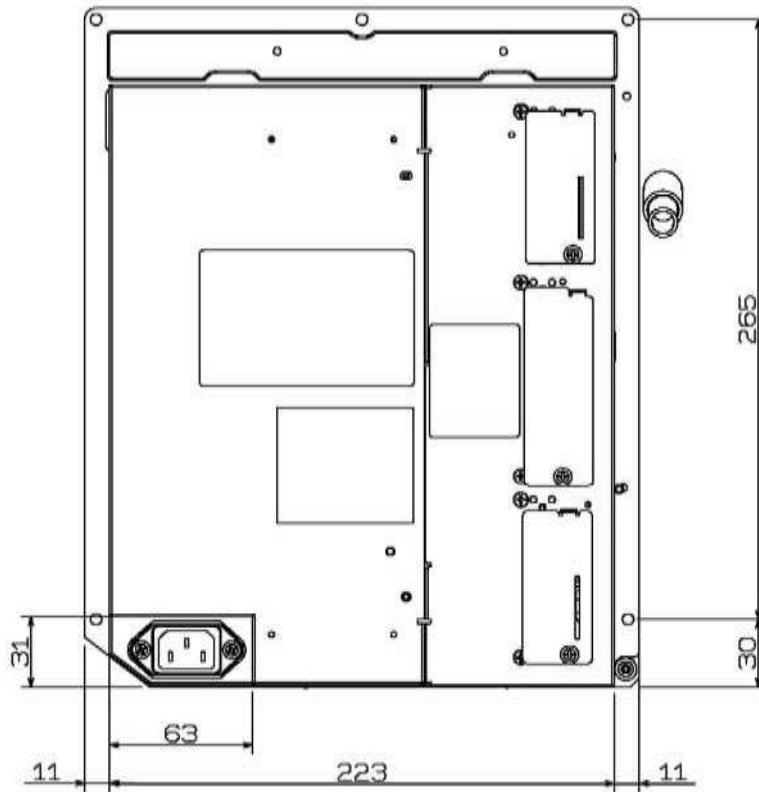

Figure 7-4f, Printer Rear View

PRINTER DIMENSIONS (OPPOSITE DIRECT LOAD)

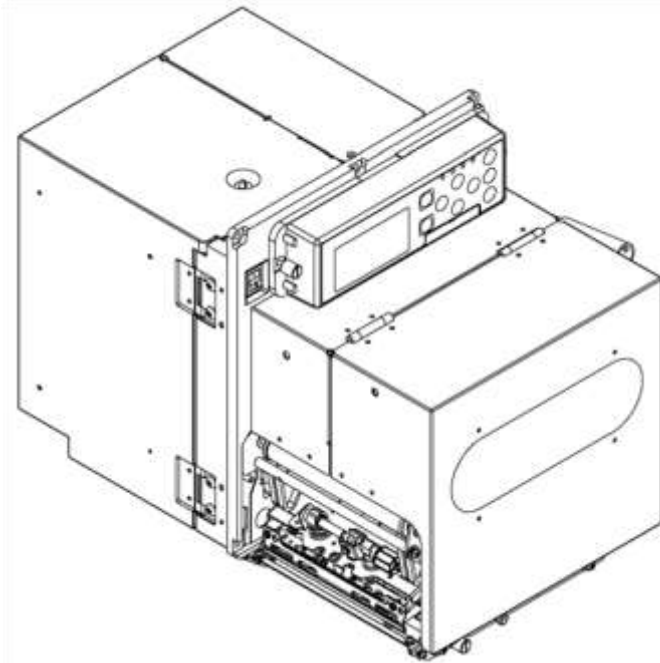

Figure 7-5a, Printer Three/Quarter View

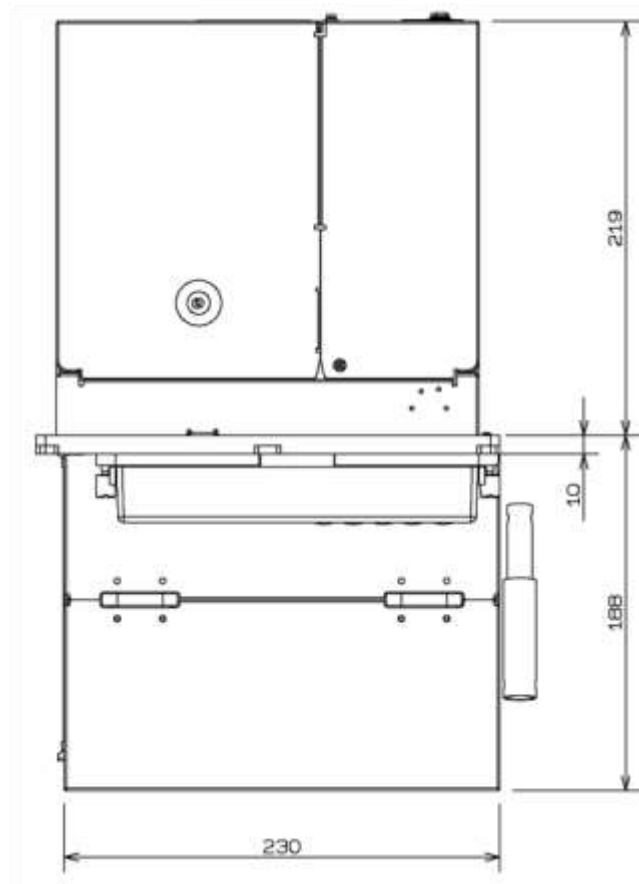

Figure 7-5b, Printer Top View

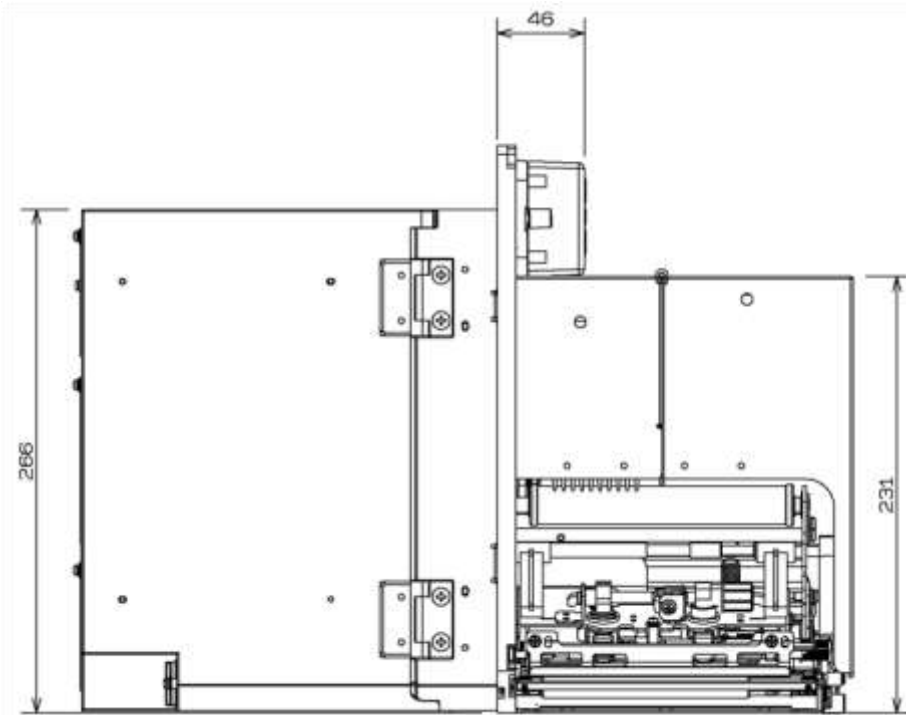

Figure 7-5c, Printer Left-Side View

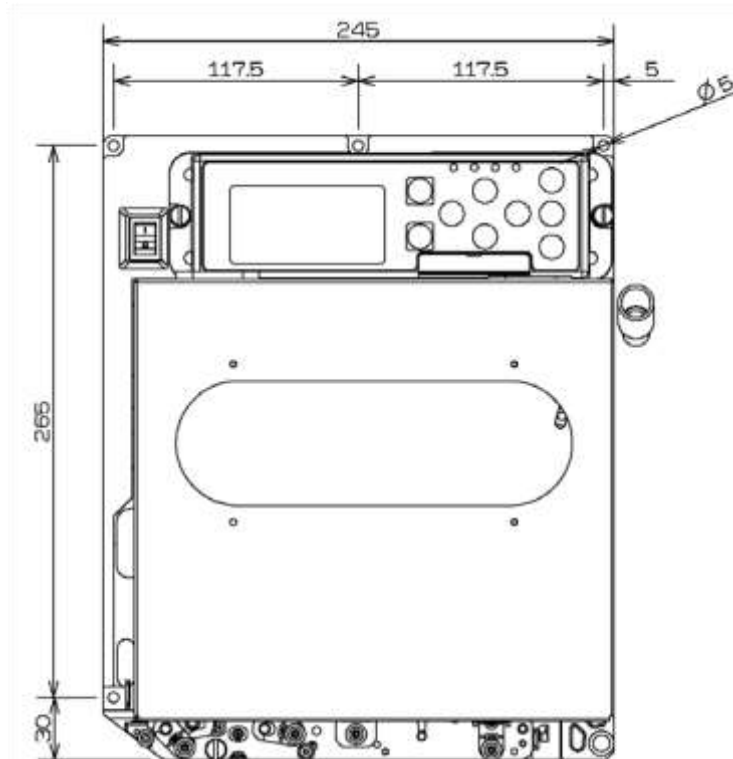

Figure 7-5d, Printer Front View

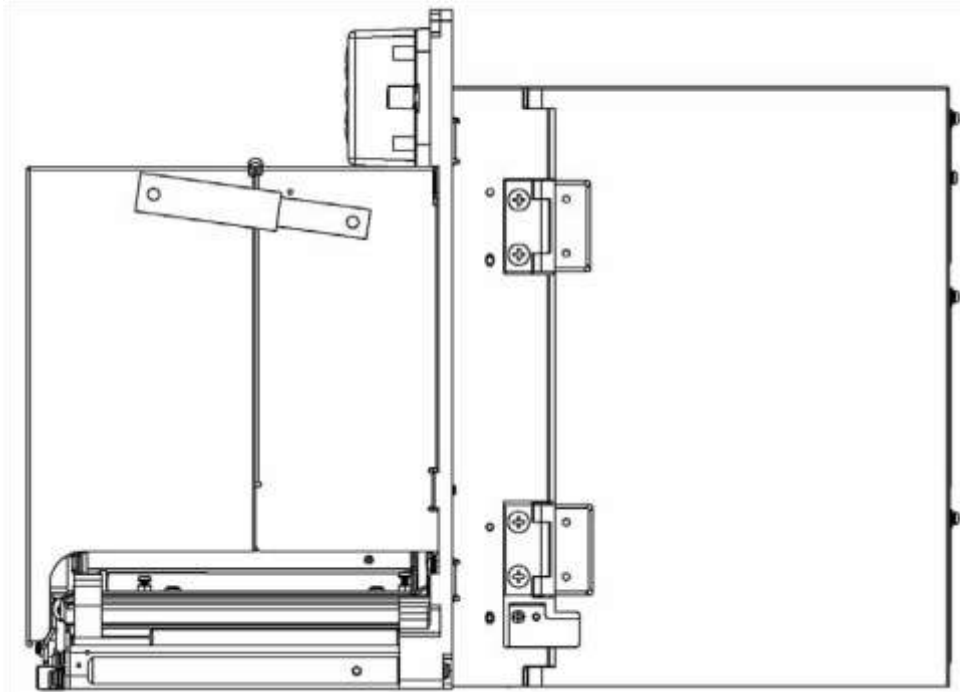

Figure 7-5e, Printer Right-Side View

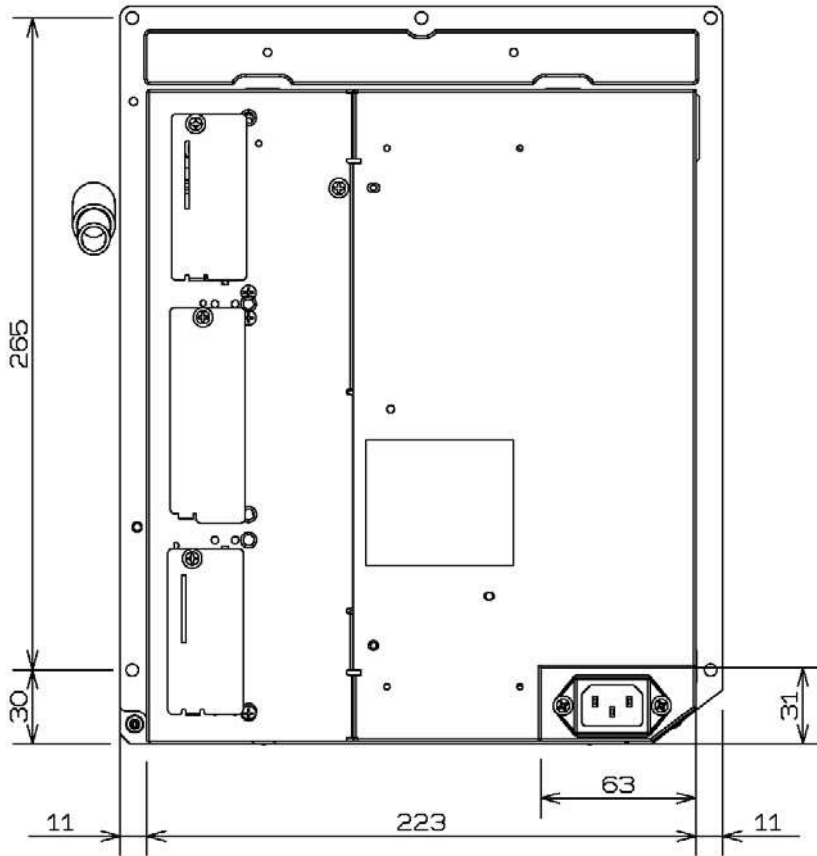

Figure 7-5f, Printer Rear View